

plaber®

READY

SPECIAL CASES 2022

We are HPRC. We don't just design and manufacture watertight hard protective cases, we supply carrying solutions. And solutions need to be no-hassle and tailored to your needs.

This is why in Autumn 2013 we designed our first case with a foam specially cut to house the DJI Phantom 1.

Now, almost 8 years later, we are a leading manufacturer of custom cases for drones, gimbals, camcorders and cameras but we feel we are still at the beginning: more is yet to come.



HPRC VECTOR PANEL

The new protective layer system designed for your Ready Case



Made of special PVC based compound, the Vector Panel ensures:

- foam long-last durability and integrity;
- improved protection for the equipment;
- dedicated item slots, suitably marked, avoiding lost tools;
- easy and quick organization of the case;
- savings in space and time;
- professional design and presentation.



The system significantly increases the overall performance and efficiency of the case in any kind of environment, weather conditions and temperature.



DJI

SPECIAL CASES 2022

HPRC2710 for DJI Phantom 4

PHA4-2710-02



- 1 DJI Phantom 4 / Pro / 4 Pro + with Props On / 4 V2.0
- 2 Cables / Miscellaneous
- 3 3 x Filters
- 4 Charger + Cables
- 5 2 x Kits of Spare Props
- 6 Spare Battery
- 7 Spare Battery / Miscellaneous Accessories
- 8 Complimentary HPRC1100 for 8 MicroSD Cards
- 9 Ipad Air / Tablet up to 10"
- 10 Controller Monitor Hood for Tablets / Instructions
- 11 Remote Controller
- 12 Cables
- 13 Small Tools

suitable for v 2.0 low noise propellers

TECHNICAL FEATURES

Dimension:

Internal dimension
555x459x256(mm) - 21.85x18.07x10.08(in)
External dimension
617x525x280(mm) - 24.29x20.67x11.02(in)



Weight:

empty: 6.71kg - 14.76lbs

Temperature rating:

Minimum Maximum
-40°C -40°F +80°C +176°F

TECHNICAL DRAWING

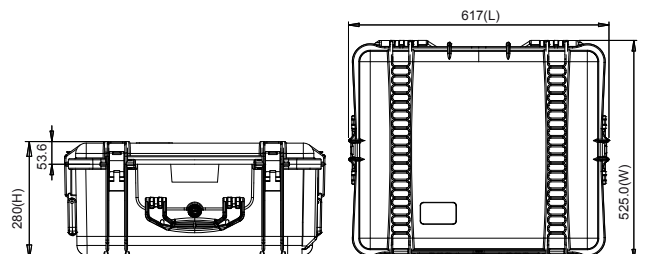

HPRC2700W for DJI Phantom 4 PHA4-2700W-02



HPRC DJI PHANTOM 4

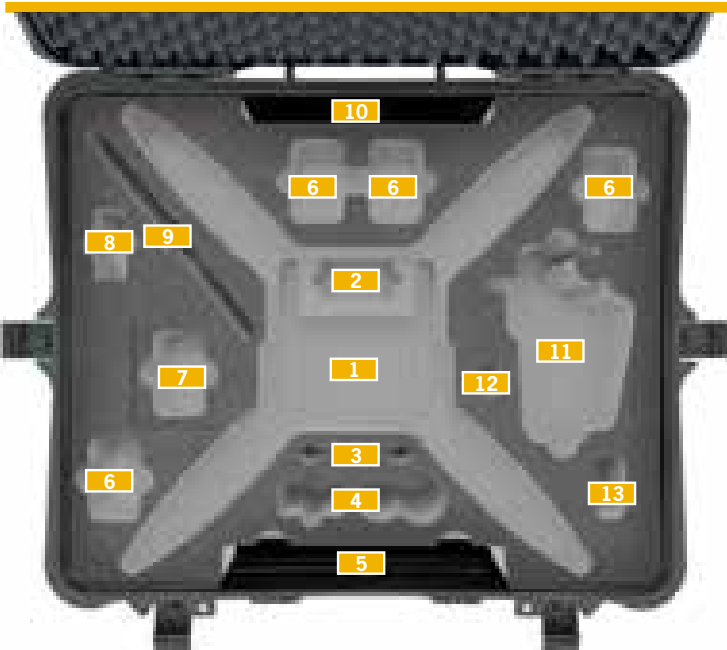

- 1 | 1 Phantom 4 / Pro / 4 Pro + with Props On / 4 V2.0
- 2 | Cables / Miscellaneous
- 3 | 3 x Filters
- 4 | Charger + Cables
- 5 | 2 x Kits of Spare Props
- 6 | Spare Battery
- 7 | Spare Battery / Miscellaneous Accessories
- 8 | Complimentary HPRC1100 for 8 MicroSD Cards
- 9 | Ipad Air / Tablet up to 10"
- 10 | Controller Monitor Hood for Tablets / Instructions
- 11 | Remote Controller
- 12 | Cables
- 13 | Small Tools

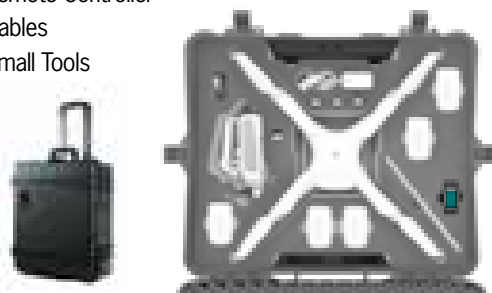

suitable for v 2.0 low noise propellers

TECHNICAL FEATURES

Dimension:

Internal dimension
554,7x458,7x246(mm) - 21.84x18.06x9.69(in)
External dimension
617,5x527,3x279,6(mm) - 24.31x20.76x11.0(in)

Weight:

empty: 7,70kg - 16.98lbs
with cubed foam: 8,72kg - 19.21lbs

Temperature rating:

Minimum Maximum
-40°C -40°F +80°C +176°F



TECHNICAL DRAWING

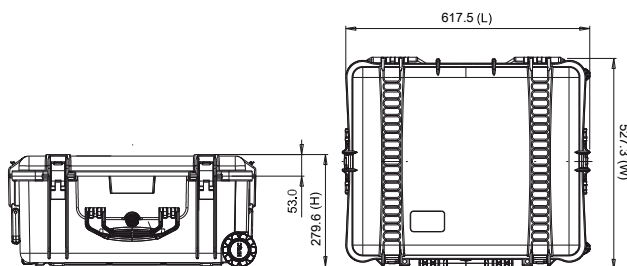

Bag for DJI Phantom 4 PHA4-BAG27-02



- 01** | Phantom 4 / Pro / 4 Pro + with Props On / 4 V2.0
- 02** | Cables / Miscellaneous
- 03** | 3 x Filters
- 04** | Charger + Cables
- 05** | 2 x Kits of Spare Props
- 06** | Spare Battery
- 07** | Spare Battery / Miscellaneous Accessories
- 08** | Complimentary HPRC1100 for 8 MicroSD Cards
- 09** | Ipad Air / Tablet up to 10"
- 10** | Controller Monitor Hood for Tablets / Instructions
- 11** | Remote Controller
- 12** | Cables
- 13** | Small Tools

suitable for v 2.0 low noise propellers

Dimension: external dimension
560x470x235(mm) - 22.05x18.50x9.25(in)

Weight:
empty: 7,70 kg - 16,98 lbs
with foam: 8,72 kg - 19,21 lbs



HPRC2700W for DJI Phantom 4RTK PHA4RTK-2700W-01



- 1 DjI Phantom 4 RTK / Multispectral
- 2 Intelligent Flight Battery
- 3 Remote Controller
- 4 Ipad Air/Tablet Up to 10"
- 5 Hprc1100 For 8 Microsd Cards
- 6 Charging Hub for WB37
- 7 Battery WB37
- 8 Charging Hub for Int.flight Battery
- 9 AC Power Adapter / Miscellaneous Accessories
- 10 Propellers

suitable for v 2.0 low noise propellers

TECHNICAL FEATURES

Dimension:

Internal dimension
554,7x458,7x246(mm) - 21.84x18.06x9.69(in)
External dimension
617,5x527,3x279,6(mm) - 24.31x20.76x11.0(in)

Weight:

empty: 7,75kg - 17.09lbs
with cubed foam: 9,07kg - 19.99lbs

Temperature rating:

Minimum Maximum
-40°C -40°F +80°C +176°F



TECHNICAL DRAWING

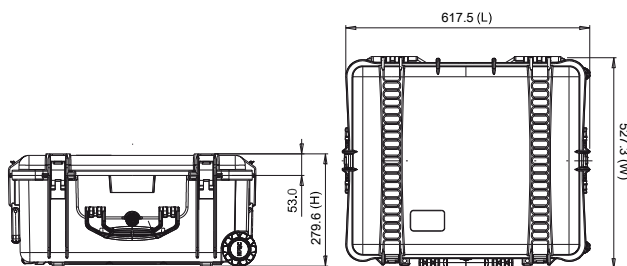

HPRC2780W for DJI Phantom 4 RTK + Ground Station PHA4RTKGS-2780W-01

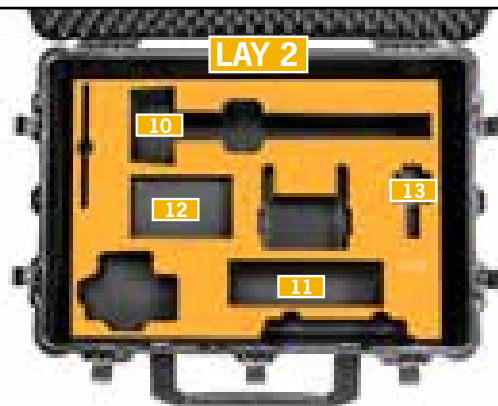
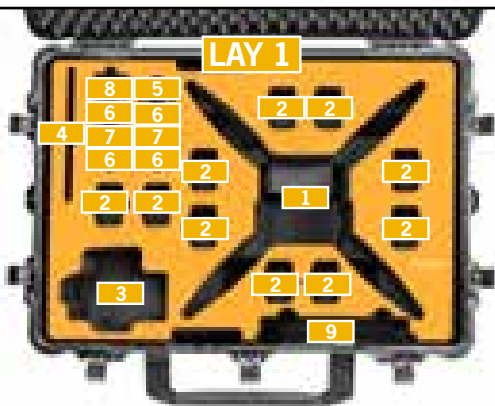
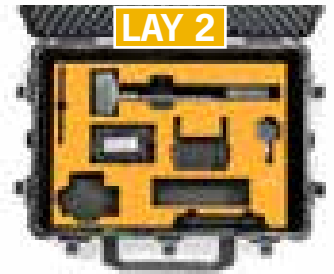

- 1** Dji Phantom 4 RTK / Phantom 4 Multispectral
- 2** Intelligent Flight Battery
- 3** Remote Controller
- 4** Ipad Air/Tablet up to 10"
- 5** Hprc 1100 for 8 MicroSD Card
- 6** Battery WB37
- 7** Charging Hub for WB37
- 8** Miscellaneous Accessories
- 9** Propellers

- 10** D-RTK 2 Body
- 11** Charging Hub for Int.flight Battery/AC Power Adapter
- 12** Miscellaneous Accessories
- 13** Mobile Phone Holder

TECHNICAL FEATURES

Dimension:

Internal dimension
748,6x524,6x363,3(mm) - 29.47x20.65x14.3(in)
External dimension
814x586,5x387,7(mm) - 32.05x23.09x15.27(in)

Weight:

empty: 12,0 kg - 26.46 lbs
with foam: 14,49 kg - 31.94 lbs

Temperature rating:

Minimum Maximum
-40°C -40°F +80°C +176°F



W

TECHNICAL DRAWING

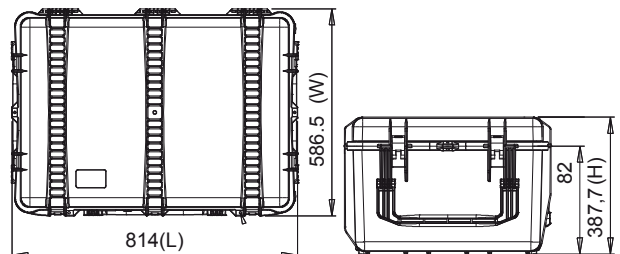

HPRC6500W for DJI D-RTK 2

DRTK6500W-01

dji
D-RTK 2



- 1** D-RTK 2 Body
- 2** Accessories Box (Mobile Phone Holder; Charging Hub, Intelligent Battery, Battery Cover, Ac Power Adapter\Cable etc)
- 3** Extension Rod
- 4** Tripod

HPRC DJI D-RTK 2

TECHNICAL FEATURES

Dimension:

Internal dimension
1280,7x279x242,8(mm) - 50.42x10.98x9.56(in)
External dimension
1328x335x299,8(mm) - 52.28x13.19x11.8(in)

Weight:

empty: 7,2kg - 15.88lbs
with cubed foam: 9,03kg - 19.90lbs

Temperature rating:

Minimum Maximum
-40°C -40°F +80°C +176°F



TECHNICAL DRAWING

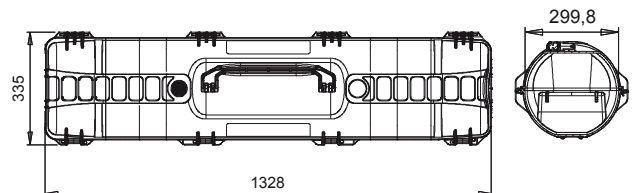



READY

HPRC2800W for DJI Matrice 300 RTK M300-2800W-02

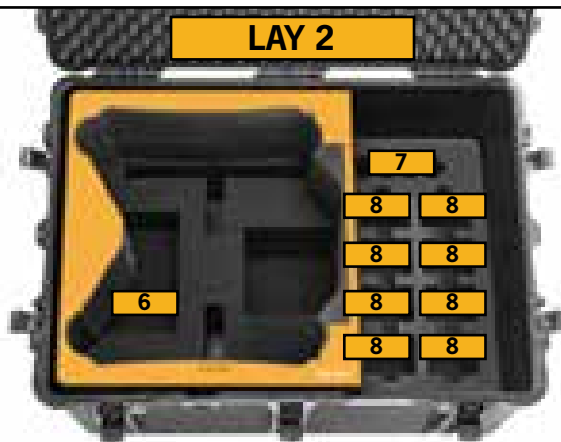
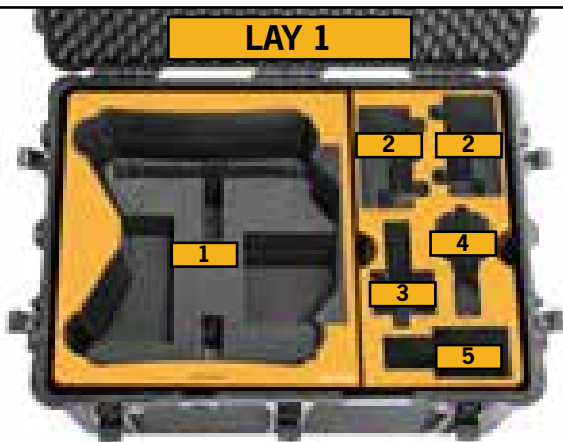

- 1** DJI Matrice 300 RTK in Landing Mode (2 Gimbal and 2 Batteries mounted)
- 2** DJI Smart Controller Enterprise (Battery Attached)
- 3** Zenmuse L1
- 4** Zenmuse P1
- 5** H20/H20T Gimbal

- 6** Propellers
- 7** WB37 Intelligent Battery
- 8** TB60 Intelligent Flight Battery



TECHNICAL FEATURES

Dimension:

Internal dimension
748,6x524,6x454,6(mm) - 29.47x20.65x17.9(in)
External dimension
813,3x586,5x480,5(mm) - 32.02x23.9x18.92(in)

Weight:

empty: 13,20 kg - 29.10 lbs
with foam: 15,84 kg - 34.91 lbs

Temperature rating:

Minimum Maximum
-40°C -40°F +80°C +176°F



TECHNICAL DRAWING

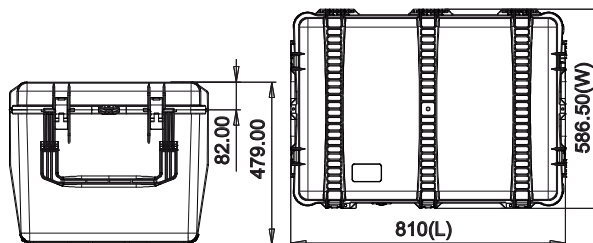

HPRC2800W for DJI Matrice 600 or Matrice 600 PRO

M600-2800W-01



- 1** DJI Matrice 600 // Matrice 600 Pro (Batteries TB47S Attached)
- 2** Hex Charger
- 3** Remote Controller
- 4** Landing Gear
- 5** Cable
- 6** Landing Gear



HPRC DJI MATRICE 600 | 600 PRO

TECHNICAL FEATURES

Dimension:

Internal dimension
748,6x524,6x454,6(mm) - 29.47x20.65x17.9(in)

External dimension
813,3x586,5x480,5(mm) - 32.02x23.9x18.92(in)

Weight:

empty: 13,20 kg - 29.10 lbs
with foam: 15,31 kg - 33.75 lbs

Temperature rating:

Minimum Maximum
-40°C -40°F +80°C +176°F



TECHNICAL DRAWING

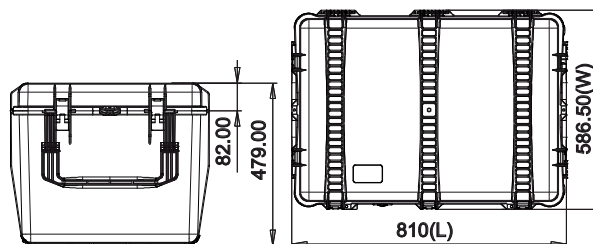

 READY



HPRC2550W for Battery DJI Matrice 300 BAT2550W-03



- 1** TB60 Intelligent Flight Battery
- 2** WB37 Intelligent Battery
- 3** Various/Perfect for Dry Keeper



HPRC DJI BATTERY CASES

TECHNICAL FEATURES

Dimension:

internal dimension
513x288x200(mm) - 20.19x11.34x7.87(in)
external dimension
549x346x236(mm) - 21.61x13.62x9.29(in)

Weight:

empty: 4.35kg - 9.57lbs

Temperature rating:

Minimum Maximum
-40°C -40°F +80°C +176°F



CABIN OK

TECHNICAL DRAWING

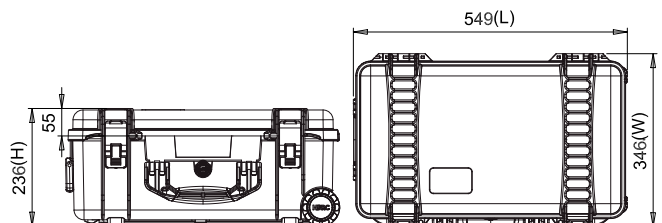

HPRC4600W for DJI Matrice 200/210 v.2.0

M210-4600W-04



dji
Matrice 210/v 2.0
Landing
Mode



LAY 1



LAY 2

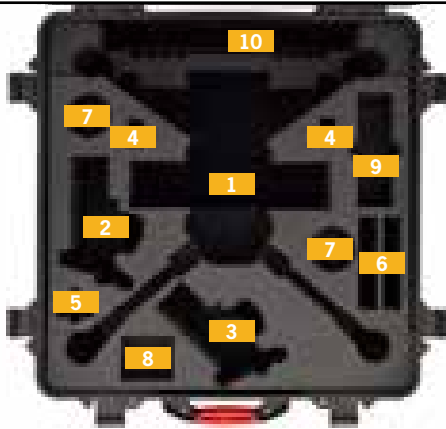

LAY 1

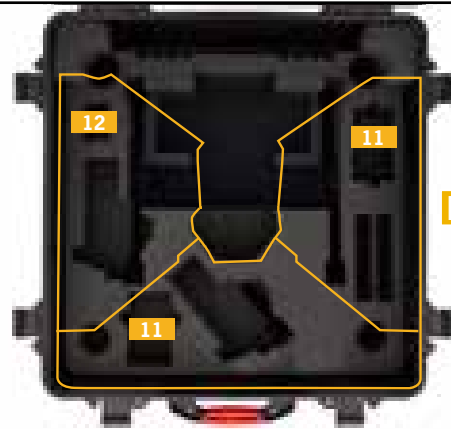

LAY 2

- 1** DJI Matrice 200/210 v.2.0 with 1 Gimbal Connector, 2 cameras, 2 GPS kit, 2 batteries TB55 mounted
- 2** Cendence Remote Controller
- 3** Cendence Remote Controller
- 4** CrystalSky Battery (WB37)
- 5** Charging Hub for CrystalSky (WCH2)
- 6** CrystalSky 7.85" with sun hood mounted
- 7** Charging Hub (IN2)
- 8** x 1 battery TB55
- 9** Battery Charger
- 10** x 4 Propellers Air

- 11** x 1 battery TB55
- 12** Small Accessories



HPRC DJI MATRICE 200/210 V.2.0

TECHNICAL FEATURES

Dimension:
internal dimension
611x611x375(mm) - 24.05x24.05x14.76(in)
external dimension
670x677x418.5(mm) - 26.38x26.65x16.48(in)

Weight:
empty: 9,9kg - 21.83lbs

Temperature rating:
Minimum Maximum
-40°C -40°F +80°C +176°F



W

TECHNICAL DRAWING

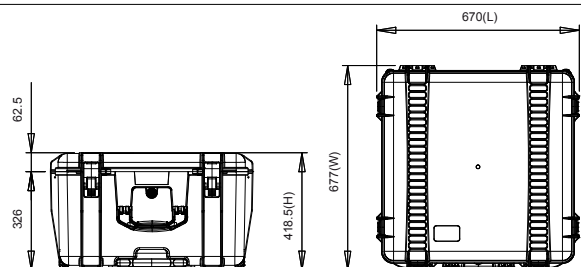

HPRC2550W Battery Case for DJI Matrice 200/210 v.2.0

BAT-2550W-02

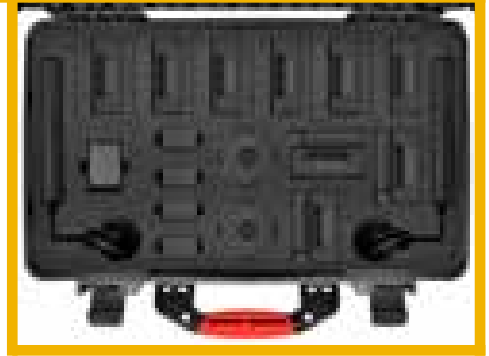

dji
BATTERY CASE
FOR DJI Matrice 210/v 2.0

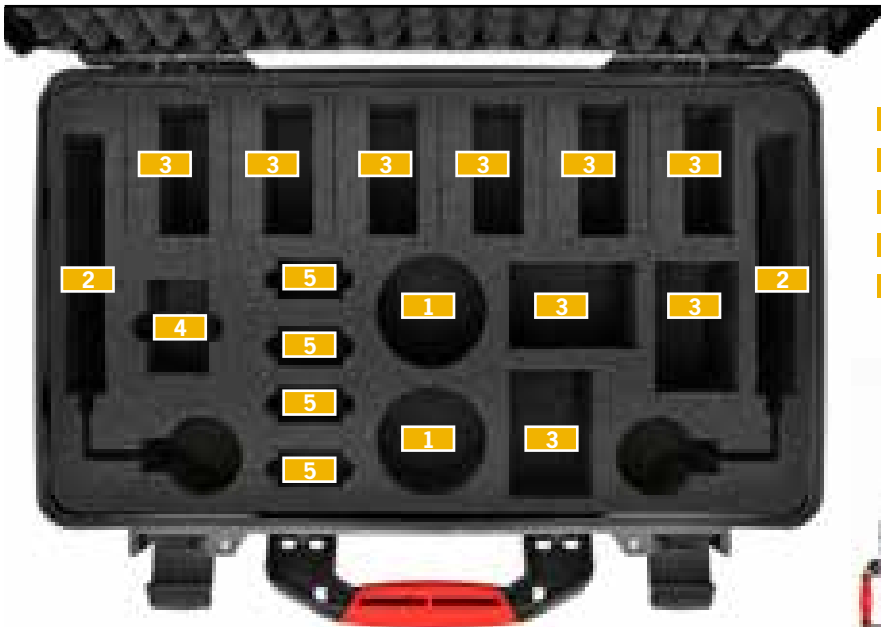

- 1** Charging Hub
- 2** Battery Charger
- 3** Battery TB50 or TB55
- 4** Charging Hub for CristalSky (WCH2)
- 5** CrystalSky Battery (WB37)



TECHNICAL FEATURES

Dimension:

internal dimension
513x288x200(mm) - 20.19x11.34x7.87(in)
external dimension
549x346x236(mm) - 21.61x13.62x9.29(in)

Weight:

empty: 4.35kg - 9.57lbs

Temperature rating:

Minimum Maximum
-40°C -40°F +80°C +176°F



TECHNICAL DRAWING

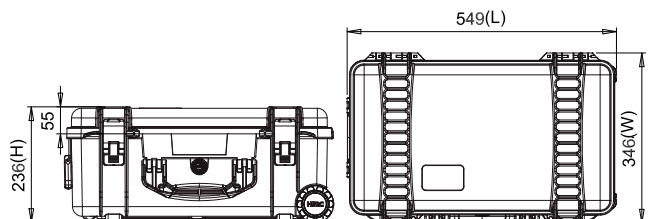

HPRC2780W for DJI Inspire 2

INS2-2780W-02



HPRC DJI INSPIRE 2

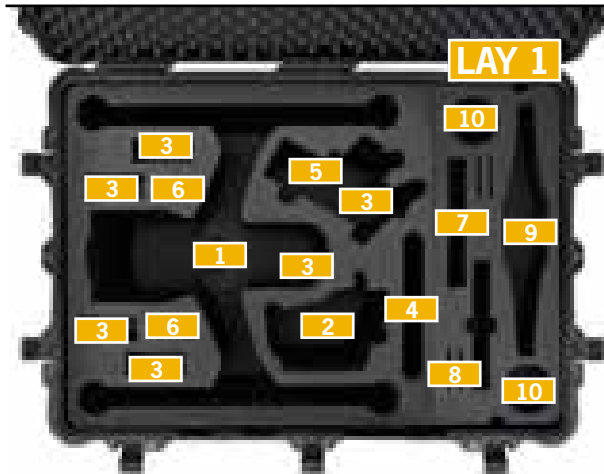

- 1** DJI Inspire 2 in Landing Mode with Gimbal X7 Attached
- 2** Transmitter (Radio Controller)
- 3** Spare Flight Battery
- 4** Crystal Monitor 7.85"
- 5** Cendence Remote Controller
- 6** SSD
- 7** Charger
- 8** Filters
- 9** Props + Spare Props
- 10** Charging Hub



- 11** Gimbal
- 12** Gimbal's Lid
- 13** Lens
- 14** Cables / Miscellaneous



- 15** Miscellaneous / Small Accessories

TECHNICAL FEATURES

Dimension:
 Internal dimension
 748,6x524,6x363,3(mm) - 29.47x20.65x14.3(in)
 External dimension
 814x586,5x387,7(mm) - 32.05x23.09x15.27(in)

Weight:
 empty: 12,22kg - 26.94lbs
 with cubed foam: 14,63kg - 32.24lbs

Temperature rating:
 Minimum Maximum
 -40°C -40°F +80°C +176°F



TECHNICAL DRAWING

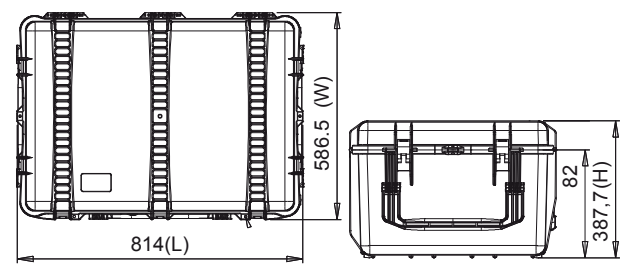

HPRC4600 for DJI Inspire 2

INS2-4600W-02

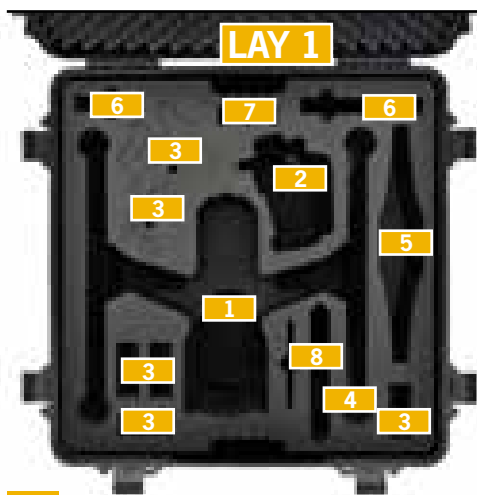
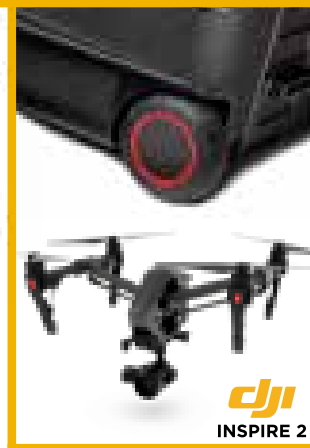

LAY 1

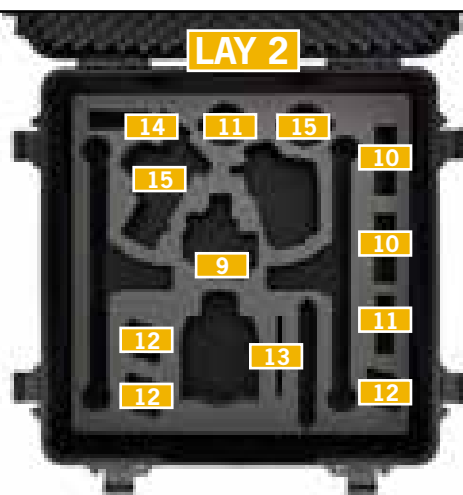

LAY 2

- 1 DJI Inspire 2 in Landing Mode with Gimbal X7 Attached
- 2 Standard Radio Controller
- 3 Spare Flight Battery
- 4 Ipad Mini / Tablet up to 7.9"
- 5 Props + Spare Props
- 6 Charger
- 7 SSD
- 8 CrystalSky 7.85"

- 9 Gimbal
- 10 Battery
- 11 Cables / Miscellaneous
- 12 Lens
- 13 Crystal Monitor
- 14 Charging Hub
- 15 Cendence Remote Controller



TECHNICAL FEATURES

Dimension:

Internal dimension
611x611x375(mm) - 24.05x24.05x14.76(in)
external dimension
670x677x418,5(mm) - 26.38x26.65x16.48(in)



W

Weight:

empty: 10,85 kg - 23.92 lbs
with foam: 12,90 kg - 28.43 lbs

Temperature rating:

Minimum Maximum
-40°C -40°F +80°C +176°F

TECHNICAL DRAWING

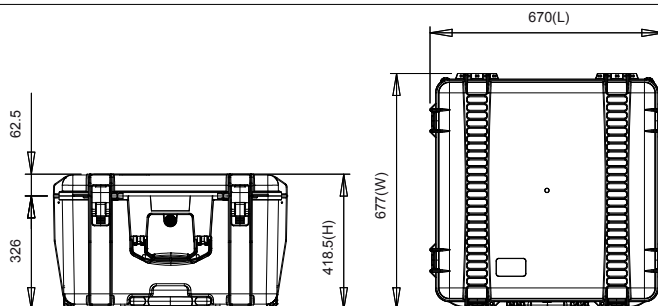

HPRC2550 for DJI inspire 2

BAT-2550W-01

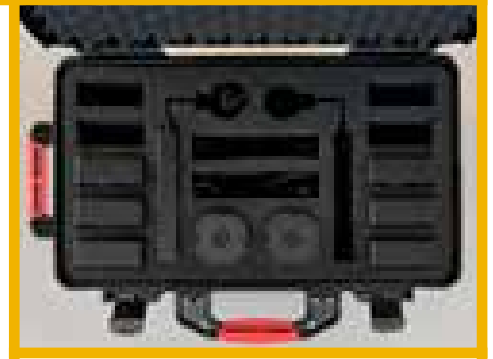

dji
INSPIRE 2



- 1** Battery for DJI Inspire 2
- 2** Charger Hub
- 3** Battery Charger
- 4** Miscellaneous



HPRC DJI INSPIRE 2

TECHNICAL FEATURES

Dimension:

internal dimension
513x288x200(mm) - 20.19x11.34x7.87(in)
external dimension
549x346x236(mm) - 21.61x13.62x9.29(in)

Weight:

empty: 4,35kg - 9.57lbs

Temperature rating:

Minimum Maximum
-40°C -40°F +80°C +176°F



TECHNICAL DRAWING

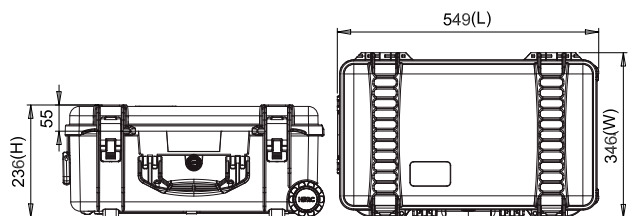

HPRC2300 for DJI Smart Controller Enterprise

SCE-2300-01



- 1** DJI Smart Controller Enterprise
- 2** Miscellaneous
- 3** Wb37 Intelligent Battery



HPRC DJI SMART CONTROLLER

TECHNICAL FEATURES

Dimension:

Internal dimension
305,7x232,4x137,5(mm) - 12.04x9.15x5.41(in)
External dimension
334,6x303x155,2(mm) - 13.17x11.93x6.11(in)



Weight:

empty: 1,75kg - 3.86lbs

Temperature rating:

Minimum Maximum
-40°C -40°F +80°C +176°F

TECHNICAL DRAWING

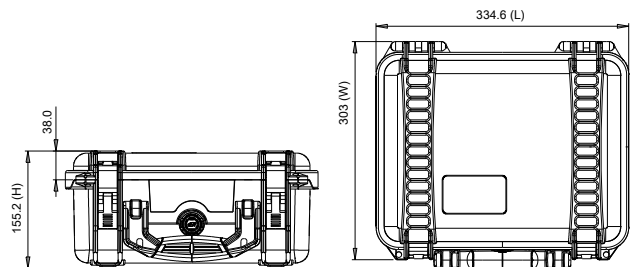

HPRC2460 for DJI Cendence

CEN2460-02



- 1 Cendence Remote Controller
- 2 CrystalSky 7.85"
- 3 Battery Charger
- 4 Charging hub for CrystalSky
- 5 CrystalSky Battery



HPRC DJI CENDENCE

TECHNICAL FEATURES

Dimension:

internal dimension
409x306x175(mm) - 16.1x12.05x6.89(in)
external dimension
435x377,8x193(mm) - 17.13x14.87x7.60(in)

Weight:

empty: 2,57kg - 5.65lbs
with cubed foam: 2,88kg - 6.35lbs

Temperature rating:

Minimum Maximum
-40°C -40°F +80°C +176°F

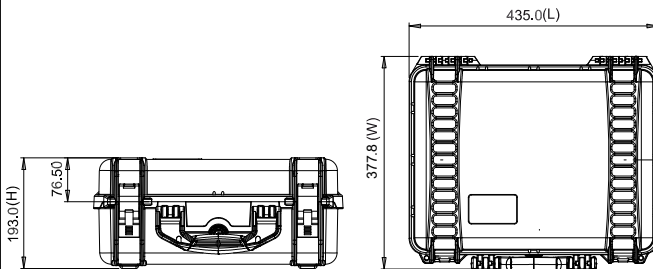

HPRC2400 for DJI Mavic 2

MAV2-2400BLK-02



- 1** Smart Controller/Battery Charger, Cables
- 2** Remote Controller/Battery Charger, Cables
- 3** Battery Charger/Adapter, Various
- 4** DJI Mavic 2 (Intelligent Flight Battery and Gimbal Protector Included)
- 5** Propellers
- 6** Usb Adapter
- 7** Little Accessories
- 8** Usb Power Adapter/cable
- 9** Intelligent Flight Batteries



HPRC DJI MAVIC 2

TECHNICAL FEATURES

Dimension:

internal dimension
377x263,9x150,8(mm) - 14.84x10.39x5.94(in)

external dimension
402x330,5x169,2(mm) - 15.83x13.01x6.66(in)

Weight:

empty: 2,38 kg - 5.25 lbs
with foam: 2,47 kg - 5.45 lbs

Temperature rating:

Minimum Maximum
-40°C -40°F +80°C +176°F



TECHNICAL DRAWING

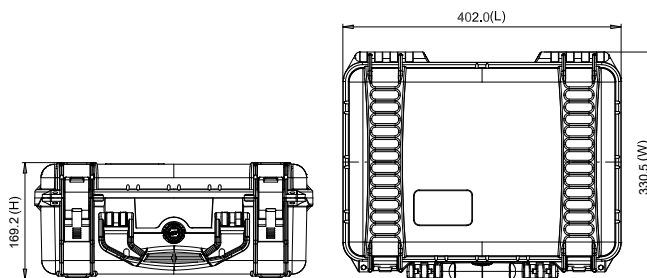

HPRC3500 for DJI Mavic 2

MAV2-3500BLK-02



- 1** DJI Mavic 2 (Intelligent Flight Battery and Gimbal Protector Included)
- 2** Remote Controller/Smart Controller
- 3** Intelligent Flight Batteries
- 4** Usb Power Adapter/cable
- 5** Mavic 2 Car Charger
- 6** Battery Charging Hub /Adapter, Various
- 7** Various / Usb Adaptor
- 8** Cables
- 9** Battery Charging Hub /Adapter, Various

TECHNICAL FEATURES

Dimension:

internal dimension
433,5x319,3x168,8(mm) - 17.07x12.57x6.65(in)
external dimension
497,9x370,3x184,9(mm) - 19.6X14.58x7.28(in)

Weight:

empty: 3,20 kg - 7.04 lbs
with foam: 3,61 kg - 7.95 lbs

Temperature rating:

Minimum Maximum
-40°C -40°F +80°C +176°F



TECHNICAL DRAWING

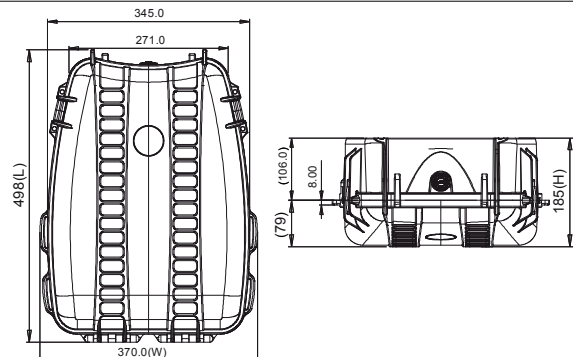

Bag for DJI Mavic 2

MAVBAG35-03



- 1** DJI Mavic 2 (Intelligent Flight Battery and Gimbal Protector Included)
- 2** Remote Controller/Smart Controller
- 3** Intelligent Flight Batteries
- 4** Usb Power Adapter/cable
- 5** Mavic 2 Car Charger
- 6** Battery Charging Hub /Adapter, Various
- 7** Various / Usb Adaptor
- 8** Cables
- 9** Battery Charging Hub /Adapter, Various

TECHNICAL FEATURES

Dimension:

internal dimension
433x319x169(mm) - 17.05x12.56x6.65(in)
external dimension
498x370x185(mm) - 19.61x14.57x7.28(in)

Weight:

empty: 0,71 kg - 1,57 lbs
with foam: 0,91 kg - 2,01 lbs



HPRC2400 for DJI Air 2S and Mavic Air 2

MAV2A-2400-02



- 1** DJI Air 2S and Mavic Air 2
- 2** Intelligent Flight Battery
- 3** Battery Charging Hub
- 4** Propellers
- 5** Battery to Power, Bank Adaptor
- 6** Nd Filter Set
- 7** Remote Controller/Smart controller
- 8** Battery Charger
- 9** Cable



HPRC DJI MAVIC MINI

TECHNICAL FEATURES

Dimension:

internal dimension
377x263,9x150,8(mm) - 14.84x10.39x5.94(in)
external dimension
402x330,5x169,2(mm) - 15.83x13.01x6.66(in)

Weight:

empty: 2,38 kg - 5.25 lbs
with foam: 2,49 kg - 5.49 lbs

Temperature rating:

Minimum Maximum
-40°C -40°F +80°C +176°F



TECHNICAL DRAWING

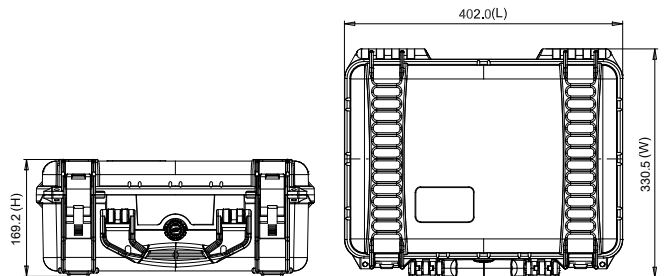

HPRC2300 for DJI Air 2S and Mavic Air 2 Fly More Combo MAV2A-2300-01



- 1** DJI Air 2S and Mavic Air 2 Fly More Combo
- 2** Battery Charger
- 3** Intelligent Flight Battery
- 4** Remote Controller/Smart Controller
- 5** Propellers
- 6** Nd Filter Set
- 7** Cable



HPRC DJI MAVIC MINI

TECHNICAL FEATURES

Dimension:

Internal dimension
305,7x232,4x137,5(mm) - 12.04x9.15x5.41(in)

External dimension
334,6x303x155,2(mm) - 13.17x11.93x6.11(in)



Weight:

empty: 1,75 kg - 3.86 lbs
with foam: 1,88 kg - 4.13 lbs

Temperature rating:

Minimum Maximum
-40°C -40°F +80°C +176°F

TECHNICAL DRAWING

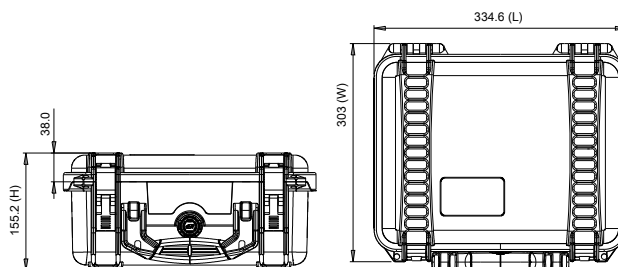

HPRC3500 for DJI Air 2S and Mavic Air 2 Fly More Combo

MAV2A-3500-01



- 1** DJI Air 2S and Mavic Air 2 Fly More Combo
- 2** Intelligent Flight Battery
- 3** Nd Filter Set
- 4** Battery Charging Hub
- 5** Cable
- 6** Battery to Power, Bank Adaptor
- 7** Propellers
- 8** Miscellaneous
- 9** Remote Controller/Smart Controller
- 10** Battery Charger

HPRC DJI MAVIC MINI

TECHNICAL FEATURES

Dimension:

internal dimension
433,5x319,3x168,8(mm) - 17.07x12.57x6.65(in)
external dimension
497,9x370,3x184,9(mm) - 19.6x14.58x7.28(in)

Weight:

empty: 3,00kg - 6.61lbs
with cubed foam: 3,55kg - 7.82lbs

Temperature rating:

Minimum Maximum
-40°C -40°F +80°C +176°F



TECHNICAL DRAWING

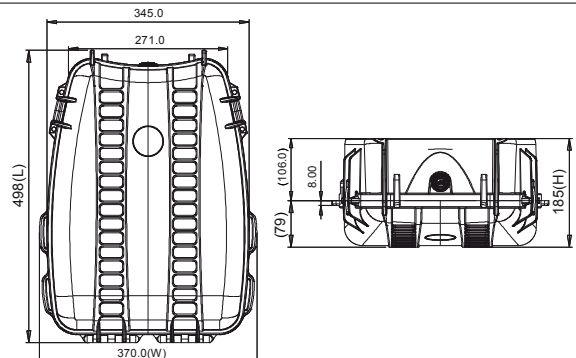

Bag for DJI Air 2S and Mavic Air 2 Fly More Combo

MAVBAG35-04

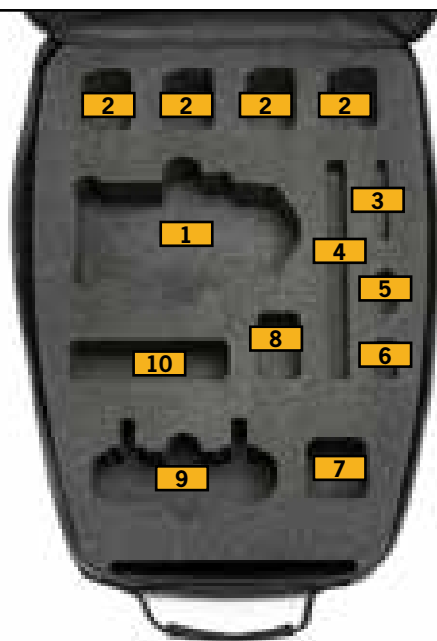

- 1** DJI Air 2S and Mavic Air 2 Fly More Combo
- 2** Intelligent Flight Battery
- 3** Nd Filter Set
- 4** Battery Charging Hub
- 5** Cable
- 6** Battery to Power, Bank Adaptor
- 7** Propellers
- 8** Miscellaneous
- 9** Remote Controller/Smart Controller
- 10** Battery Charger

TECHNICAL FEATURES

Dimension:

internal dimension
433x319x169(mm) - 17.05x12.56x6.65(in)

external dimension
498x370x185(mm) - 19.61x14.57x7.28(in)



HPRC2300 FOR DJI Mini 2 Combo Fly More MAVM-2300-02



- 1** Aircraft
- 2** Cable/Miscellaneous
- 3** Intelligent Flight Battery
- 4** DJI 18W USB Charger
- 5** Two-Way Charging Hub
- 6** Remote Controller
- 7** Propellers



HPRC DJI MAVIC MINI

TECHNICAL FEATURES

Dimension:

Internal dimension
305,7x232,4x137,5(mm) - 12.04x9.15x5.41(in)

External dimension
334,6x303x155,2(mm) - 13.17x11.93x6.11(in)



Weight:

empty: 1,77kg - 3.89lbs
with cubed foam: 1,96kg - 4.32lbs

Temperature rating:

Minimum Maximum
-40°C -40°F +80°C +176°F

TECHNICAL DRAWING

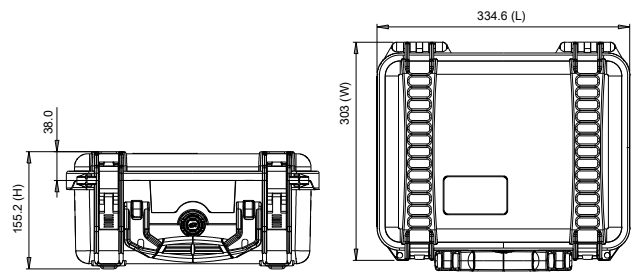



HPRC2500 for DJI FPV Combo

FPV-2500-01

NEW



- 1** DJI FPV Drone
- 2** Goggles Battery
- 3** Fly More kit
- 4** Goggles V2 with Goggles Antenna (or TrueRC) mounted
- 5** Remote Controller
- 6** Motion Controller
- 7** AC Power Adaptor
- 8** Intelligent Flight Battery
- 9** Propellers (Pair)/Cable

HPRC DJI FPV DRONE

TECHNICAL FEATURES

Dimension:
 internal dimension
 449,8x322,9x174,9(mm) - 17.71x12.71x6.89(in)
 external dimension
 478,1x389,4x194(mm) - 18.82x15.33x7.64(in)

Weight:
 empty: 3,22kg - 7.10lbs
 with cubed foam: 3,69kg - 8.12lbs

Temperature rating:
 Minimum Maximum
 -40°C -40°F +80°C +176°F



TECHNICAL DRAWING

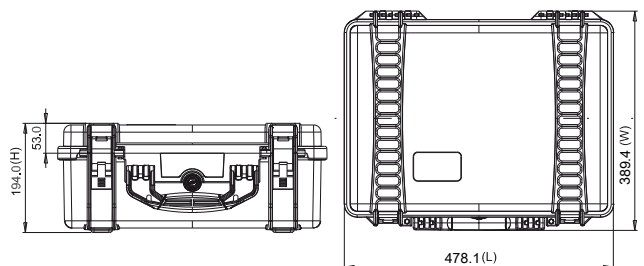

HPRC3600 for DJI FPV Combo

FPV-3600-01

NEW



- 1** DJI FPV Drone
- 2** Goggles Battery
- 3** Intelligent Flight Battery
- 4** AC Power Adaptor
- 5** Fly More kit
- 6** Propellers (Pair)/Cable
- 7** Miscellaneous/Motion Controller
- 8** Miscellaneous
- 9** Remote Controller
- 10** Goggles V2 with Goggles Antenna (or TrueRC) mounted

TECHNICAL FEATURES

Dimension:

Internal dimension
479x354x194(mm) - 18.86x13.94x7.64(in)
External dimension
542x402x220(mm) - 21.34x15.83x8.66(in)



Weight:

empty: 3,23 kg - 7,11 lbs
with foam: 3,75 kg - 8,26 lbs

Temperature rating:

Minimum Maximum
-40°C -40°F +80°C +176°F

TECHNICAL DRAWING

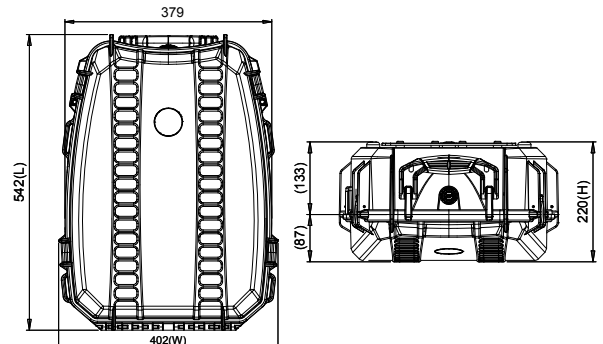



HPRC 1400 for DJI POCKET 2 CREATIVE COMBO KIT OSMPKT-1400-02



- 1** DJI Pocket 2 with 1/4"-20 Tripod Mounted
- 2** Micro Tripod
- 3** Mini Control Stick
- 4** Cable/Wireless Microphone Windscreen
- 5** Do-it-All Handle
- 6** Wireless Microphone Transmitter/SD Card
- 7** Wide-Angle Lens
- 8** Lightning (iOS) Smartphone Adapter/ USB Type-C Smartphone Adapter

TECHNICAL FEATURES

Dimension:

internal dimension
180x110x40(mm) - 7.08x4.33x1.57(in)
external dimension
200,3x142,4x48(mm) - 7.89x5.61x1.89(in)

Weight:

empty: 0,26kg - 0.57lbs

Temperature rating:

Minimum Maximum
-40°C -40°F +80°C +176°F



TECHNICAL DRAWING

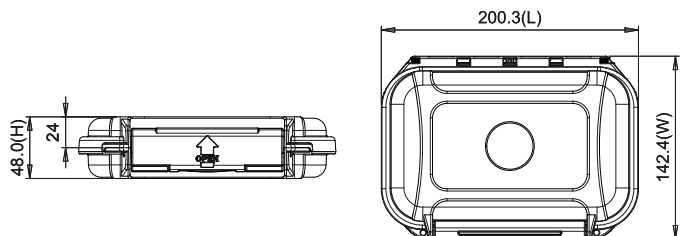

HPRC1400 for DJI OSMO POCKET OSMPKT-1400-01



- 1 DJI Osmo Pocket
- 2 Accessories / Power Cable
- 3 SD Card Rack
- 4 Smartphone adapters

HPRC DJI OSMO POCKET

TECHNICAL FEATURES

Dimension:

internal dimension
180x110x40(mm) - 7.08x4.33x1.57(in)
external dimension
200,3x142,4x48(mm) - 7.89x5.61x1.89(in)

Weight:

empty: 0,26kg - 0.57lbs

Temperature rating:

Minimum Maximum
-40°C -40°F +80°C +176°F



TECHNICAL DRAWING

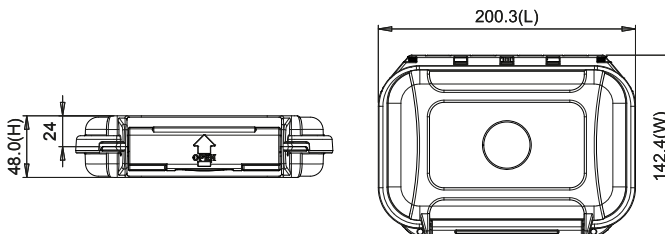

HPRC1400 for DJI OSMO ACTION

OSMACT-1400-01



- 1** Osmo Action and Camera Frame
- 2** Battery
- 3** Quick Release Base
- 4** SD Card Rack
- 5** USB-C Cable Flat
- 6** Locking Screw

HPRC DJI OSMO ACTION

TECHNICAL FEATURES

Dimension:

internal dimension
180x110x40(mm) - 7.08x4.33x1.57(in)
external dimension
200,3x142,4x48(mm) - 7.89x5.61x1.89(in)

Weight:

empty: 0,26kg - 0.57lbs

Temperature rating:

Minimum Maximum
-40°C -40°F +80°C +176°F

TECHNICAL DRAWING

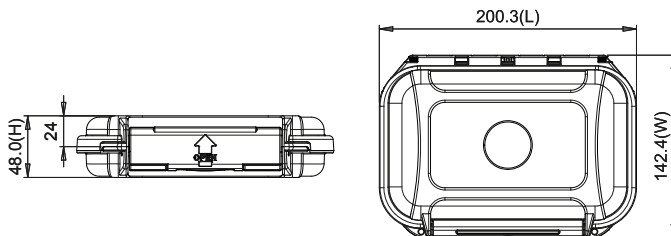

HPRC2460 for DJI Goggles

GGG-2460-01



- 1 Headband
- 2 DJI Goggles Body
- 3 Cables / Miscellaneous Accessories
- 4 Eu Charger
- 5 Uk Charger

HPRC DJI GOGGLES

TECHNICAL FEATURES

Dimension:
 internal dimension
 409x306x175(mm) - 16.1x12.05x6.89(in)
 external dimension
 435x377,8x193(mm) - 17.13x14.87x7.60(in)

Weight:
 empty: 2,57kg - 5.65lbs
 with cubed foam: 2,90kg - 6.38lbs

Temperature rating:
 Minimum Maximum
 -40°C -40°F +80°C +176°F

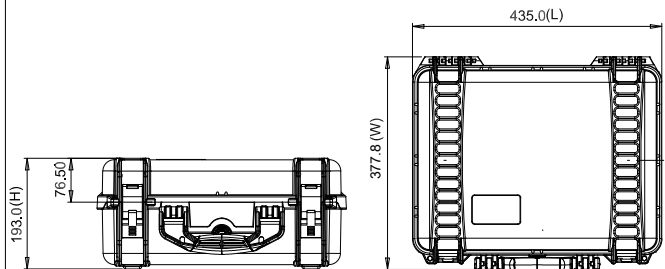

HPRC2500 for DJI RSC 2 Pro Combo

RSC2-2500-01

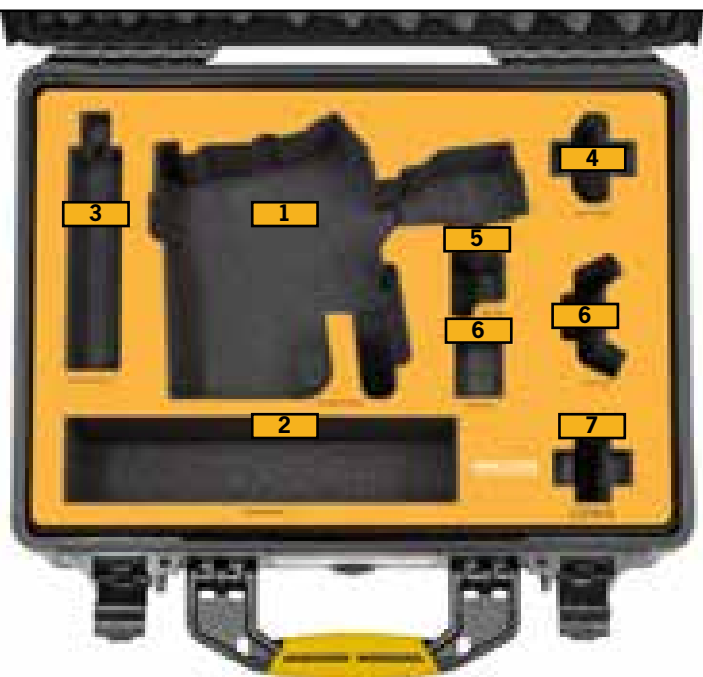

- 1** Gimbal (Built-In Battery)
- 2** Cable/Miscellaneous
- 3** Extended Grip/Tripod
- 4** Image Transmitter
- 5** Focus Motor
- 6** Phone Holder
- 7** Quick-Release Plate (Arca-Swiss/Manfrotto)

HPRC DJI RSC 2 PRO COMBO

TECHNICAL FEATURES

Dimension:
 internal dimension
 449,8x322,9x174,9(mm) - 17.71x12.71x6.89(in)
 external dimension
 478,1x389,4x194,0(mm) - 18.82x15.33x7.64(in)

Weight:
 empty: 3,22kg - 7.10lbs
 with cubed foam: 3,78kg - 8.33lbs

Temperature rating:
 Minimum Maximum
 -40°C -40°F +80°C +176°F



TECHNICAL DRAWING

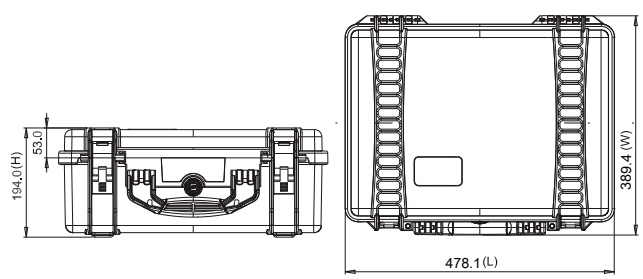

HPRC2500 for DJI RS 2 Pro Combo

RS2-2500-01



- 1** Gimbal
- 2** Cable/Miscellaneous
- 3** Briefcase Handle
- 4** Phone Holder
- 5** Image Transmitter
- 6** Quick-Release Plate (Arca-Swiss/Manfrotto)
- 7** Focus Motor
- 8** BG30 Grip
- 9** Extended Grip/Tripod (Metal)



HPRC DJI RS 2 PRO COMBO

TECHNICAL FEATURES

Dimension:

internal dimension
449,8x322,9x174,9(mm) - 17.71x12.71x6.89(in)
external dimension
478,1x389,4x194(mm) - 18.82x15.33x7.64(in)

Weight:

empty: 3,22kg - 7.10lbs
with cubed foam: 3,79kg - 8.34lbs

Temperature rating:

Minimum Maximum
-40°C -40°F +80°C +176°F



TECHNICAL DRAWING

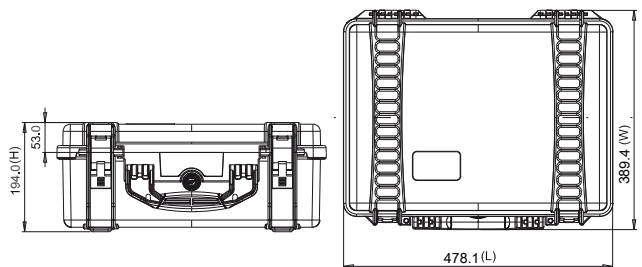

HPRC3500 for DJI RS 2 Pro Combo

RS2-3500-01



- 1** Gimbal
- 2** Cable/Miscellaneous
- 3** Quick-Release Plate (Arca-Swiss/Manfrotto)
- 4** Briefcase Handle
- 5** BG30 Grip/ Extended Grip/Tripod (Metal)
- 6** Phone Holder
- 7** Cable/Miscellaneous

TECHNICAL FEATURES

Dimension:

internal dimension
433x319x168,8(mm) - 17.07x12.57x6.65(in)
external dimension
497,9x370,3x184,9(mm) - 19.6x14.58x7.28(in)

Weight:

empty: 3,00kg - 6.61lbs
with cubed foam: 3,55kg - 7.82lbs

Temperature rating:

Minimum Maximum
-40°C -40°F +80°C +176°F



TECHNICAL DRAWING

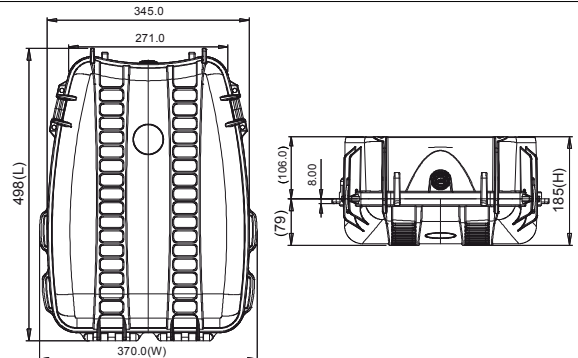

HPRC Bag for DJI RS 2 Pro Combo

RS2-BAG35-01

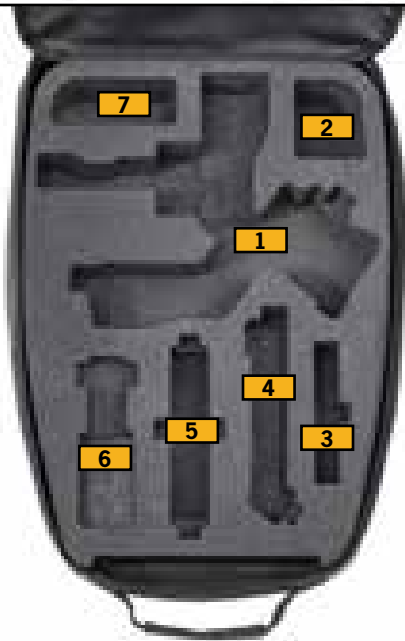

- 1** Gimbal
- 2** Cable/Miscellaneous
- 3** Quick-Release Plate (Arca-Swiss/Manfrotto)
- 4** Briefcase Handle
- 5** BG30 Grip/ Extended Grip/Tripod (Metal)
- 6** Phone Holder
- 7** Cable/Miscellaneous

TECHNICAL FEATURES

Dimension:

internal dimension
433x319x169(mm) - 17.05x12.56x6.65(in)

external dimension
498x370x185(mm) - 19.61x14.57x7.28(in)





READY



 READY

HPRC2730W for DJI Robomaster S1

ROB-2730W-01



- 1** Robomaster
- 2** Tablet up to 12,9"
- 3** Charger Cable
- 4** Battery
- 5** Protective Glasses
- 6** Gel Beads Container
- 7** Gel Beads Bottle
- 8** Cup
- 9** Gamepad
- 10** Tape
- 11** Miscellaneous\Small Accessories
- 12** Battery Charger
- 13** Vision Markers (Cardboard Signs)



HPRC DJI ROBOMASTER S1

TECHNICAL FEATURES

Dimension:

internal dimension
503x459x316(mm) - 19.80x18.07x12.44(in)
external dimension
616,9x531x349,6(mm) - 24.29x20.91x13.76(in)

Weight:

empty: 8,41kg - 18.54lbs
with cubed foam: 10,43kg - 22.99lbs

Temperature rating:

Minimum Maximum
-40°C -40°F +80°C +176°F



TECHNICAL DRAWING

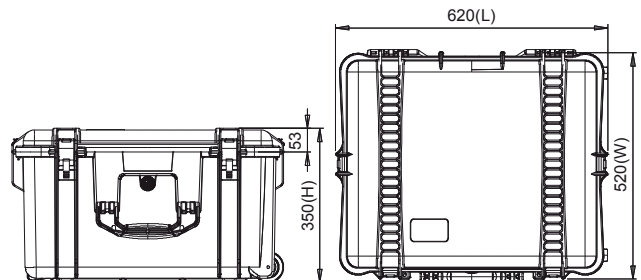



AUTEL ROBOTICS



SPECIAL CASES 2022

HPRC2400 Autel Robotics EVO II 6K / 8K Drone

EVO2-2400-02

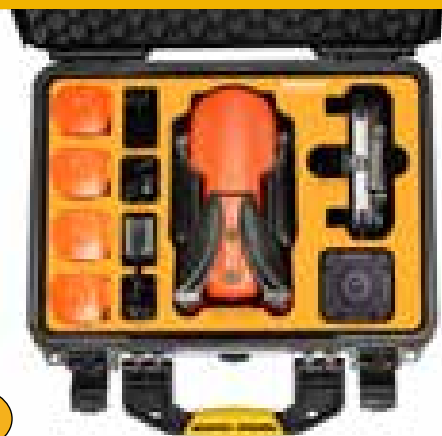

- 1** Autel Robotics EVO II 6K / 8K with propellers - low noise
- 2** Remote Controller
- 3** Battery Charging Hub
- 4** Flight Battery
- 5** Cable/Propellers/Accessories
- 6** Micro USB Cable
- 7** Charger



HPRC AUTEL ROBOTICS

TECHNICAL FEATURES

Dimension:

Internal dimension
377x263,9x150,8(mm) - 14.84x10.39x5.94(in)
External dimension
402x330,5x169,2(mm) - 15.83x13.01x6.66(in)

Weight:

empty: 2,38kg - 5.25lbs

Temperature rating:

Minimum Maximum
-40°C -40°F +80°C +176°F



TECHNICAL DRAWING

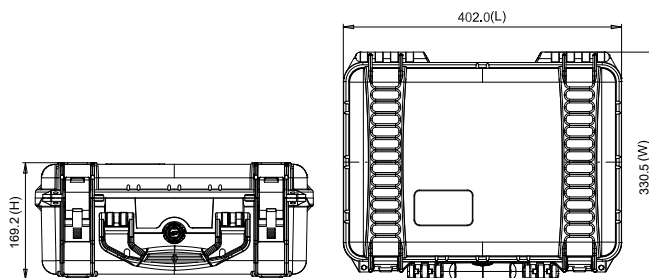



ATOMOS



SPECIAL CASES 2022

HPRC2300 for Atomos Ninja V

NJAV-2300-01



- 1** Ninja Atomos V with AtomX SSD mini and Battery mounted
- 2** Ninja V Sunhood
- 3** Battery
- 4** 12V-3A AC Power Supply
- 5** Cables/Miscellaneous
- 6** 3 Master Caddy II
- 7** Lector docking station USB-C 3.1
- 8** Battery Eliminator
- 9** Power kit Atomos

TECHNICAL FEATURES

Dimension:

Internal dimension
305,7x232,4x137,5(mm) - 12.04x9.15x5.41(in)
External dimension
334,6x303x155,2(mm) - 13.17x11.93x6.11(in)

Weight:

empty: 1,75kg - 3.86lbs
with cubed foam: 1,90kg - 4.19lbs

Temperature rating:

Minimum Maximum
-40°C -40°F +80°C +176°F



TECHNICAL DRAWING

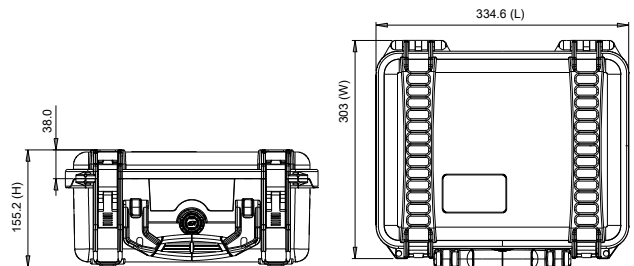





H READY

HPRC2400 Atomos Shogun 7 + Accessory Kit

SHG7-2400-01

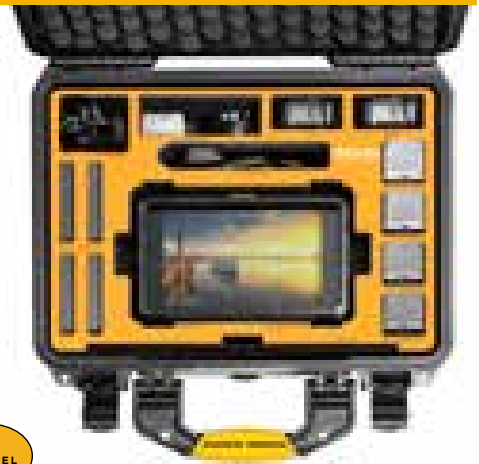

- 1** Atomos Shogun 7
- 2** USB 3.0 docking station
- 3** International Adapter
- 4** Cable
- 5** Fast charger
- 6** NP-F750 5200mAh Batteries
- 7** HDR Sunhood
- 8** Master Caddy II drive caddies
- 9** AC Power Adapter
- 10** Miscellaneous Accessories



HPRC ATOMOS SHOGUN 7

TECHNICAL FEATURES

Dimension:

Internal dimension
377x263,9x150,8(mm) - 14.84x10.39x5.94(in)
External dimension
402x330,5x169,2(mm) - 15.83x13.01x6.66(in)

Weight:

empty: 2,23kg - 4.91lbs
with cubed foam: 2,46kg - 5.42lbs

Temperature rating:

Minimum Maximum
-40°C -40°F +80°C +176°F



TECHNICAL DRAWING

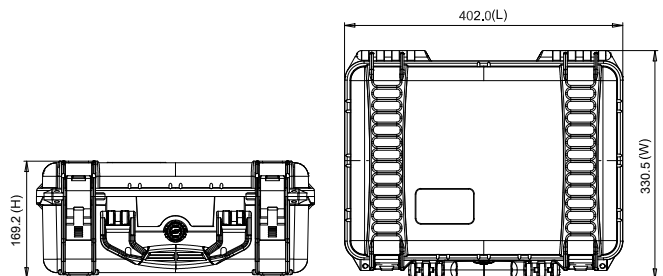



HPRC2730W for Atomos Sumo19

SM19-2730W-01



- 1** Atomos Sumo 19" Monitor Recorder
- 2** Atomos Sunhood

- 3** Charger
- 4** 3 Master caddy II
- 5** DM-130A Gold Mount Mini Battery or similar
- 6** D-4BA Battery Extender or similar

TECHNICAL FEATURES

Dimension:

internal dimension
503x459x316(mm) - 19.80x18.07x12.44(in)
external dimension
616,9x531x349,6(mm) - 24.29x20.91x13.76(in)

Weight:

empty: 8,41kg - 18.54lbs
with cubed foam: 10,43kg - 22.99lbs

Temperature rating:

Minimum Maximum
-40°C -40°F +80°C +176°F

TECHNICAL DRAWING

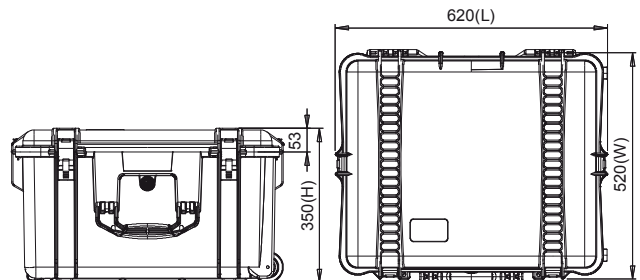



H 1700
APAC

SUNG



MATTEBOX

SPECIAL CASES 2022

HPRC2600 for Tilta MB-T12 Mattebox

T12MB-2600-01



- 1 Carbon fiber body with 15mm LWS attached
- 2 Top French flag
- 3 Step-down rings
- 4 Hard Mattes (16-20mm, 24-28mm, 32-35mm, 50-85mm, 85-180mm)
- 5 Miscellaneous
- 6 Miscellaneous



HPRC TILTA MB-T12 MATTEBOX

TECHNICAL FEATURES

Dimension:

internal dimension
482,4x358,3x198,1(mm) - 18.99x14.1x7.8(in)
external dimension
543,4x426,8x218,1(mm) - 21.39x16.8x8.59(in)



Weight:

empty: 4,31kg - 9.50lbs
with cubed foam: 5,03kg - 11.09lbs

Temperature rating:

Minimum Maximum
-40°C -40°F +80°C +176°F

TECHNICAL DRAWING

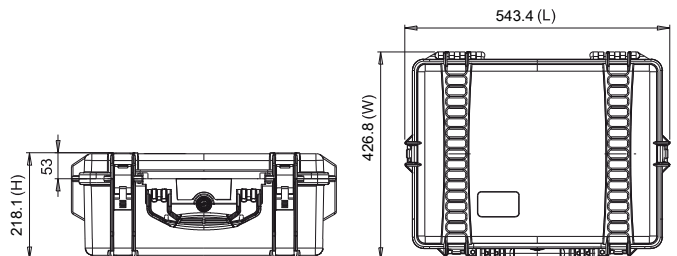



MOZA



SPECIAL CASES 2022

HPRC2530 for Moza Air2 Ifocus

MAIR2-2530-01

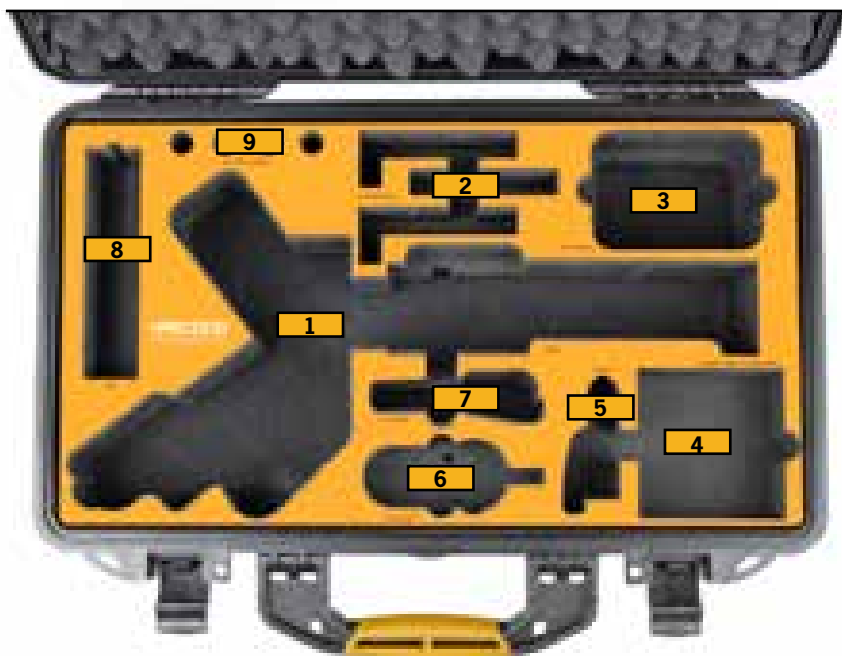
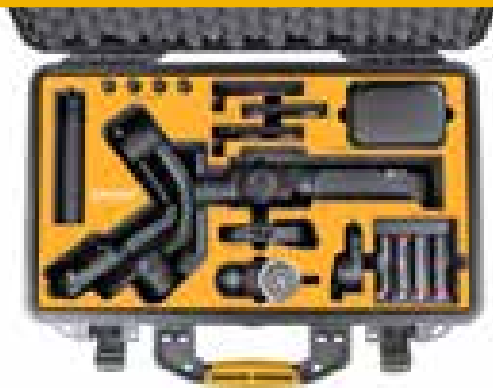

- 1** Gimbal
- 2** Quick Release Plate
- 3** Cable storage bag
- 4** Intelligent Charger and 18650 batteries
- 5** Ifocus M
- 6** Ifocus Handunit
- 7** Ifocus Motor
- 8** Tripod
- 9** Follow focus install pipe



TECHNICAL FEATURES

Dimension:

internal dimension 513x288x132(mm) - 20.20x11.34x5.20(in)
 external dimension 540x350x153(mm) - 21.26x13.78x6.02(in)

Weight:

empty: 3,20kg - 7.05lbs
 with cubed foam: 3,26kg - 7.19lbs

Temperature rating:

Minimum Maximum
 -40°C -40°F +80°C +176°F

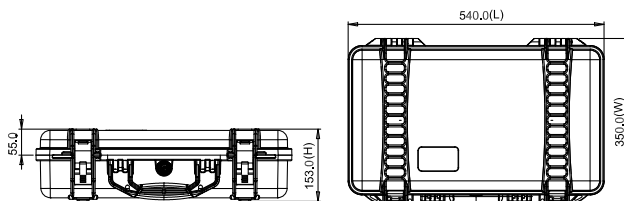



ZHIYUN CRANE

Powered by Zhiyun
CRANE 3

SPECIAL CASES 2022

HPRC2600W for ZHIYUN Crane 3 Lab CR3-2600W-01



- 1** Crane 3 Lab Stabilizer
- 2** TransMount Handheld Tripod
- 3** Battery Charger
- 4** Batteries 18650
- 5** Cable Storage Case
- 6** Quick Release Plate
- 7** TransMount Phone Holder



HPRC ZHIYUN CRANE 3 LAB

TECHNICAL FEATURES

Dimension:

Internal dimension
482,4x358,3x217,6(mm) - 18.99x14.1x8.57(in)
External dimension
546,9x426,8x250,7(mm) - 21.53x16.8x9.87(in)

Weight:

empty: 6,05kg - 13.34lbs
with cubed foam: 6,97kg - 15.37lbs

Temperature rating:

Minimum Maximum
-40°C -40°F +80°C +176°F



TECHNICAL DRAWING

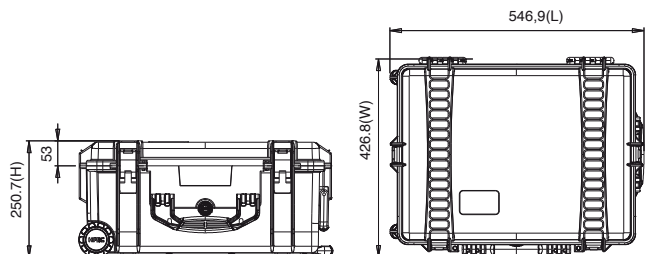

HPRC2700W for ZHIYUN Crane 3 Lab Master package

CR3-2700W-01

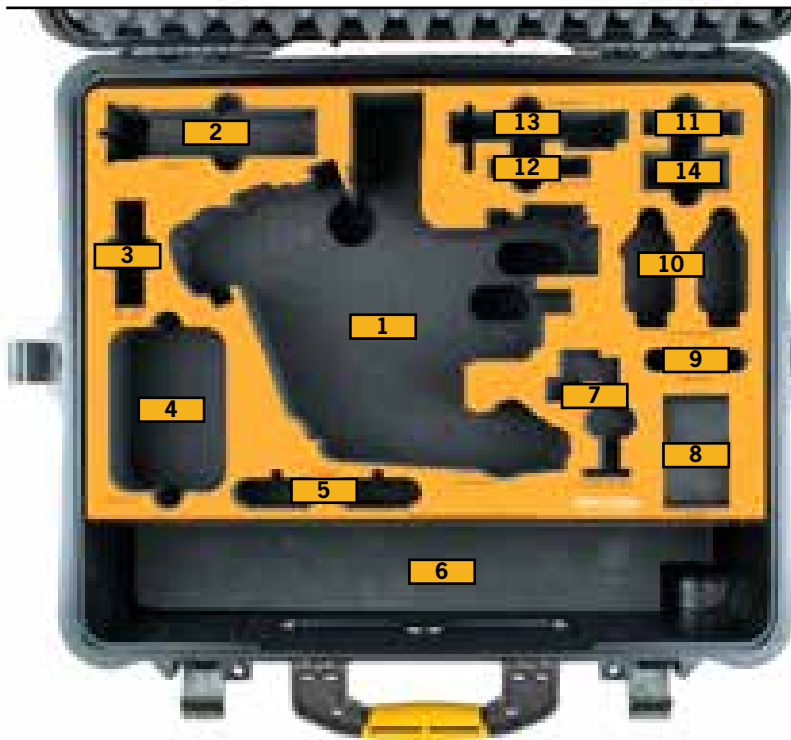

- 1** Crane 3 Lab Stabilizer
- 2** Handheld Tripod
- 3** Battery Charger
- 4** Cable Storage Case
- 5** Quick Setup Kits
- 6** Telescopic Monopod with Locking Buckle and Multifunctional Camera Belt
- 7** Phone Holder with Crown Gear
- 8** Miscellaneous
- 9** Batteries 18650
- 10** Focus and Zoom Combo Kits
- 11** Cable
- 12** Quick Release Base Plate
- 13** Quick Release Plate
- 14** HPRC1100 (not included)



HPRC ZHIYUN CRANE 3

TECHNICAL FEATURES

Dimension:

Internal dimension
554,7x458,7x246(mm) - 21.84x18.06x9.69(in)
External dimension
617,5x527,3x279,6(mm) - 24.31x20.76x11.0(in)

Weight:

empty: 7,74kg - 17.06lbs
with cubed foam: 8,84kg - 19.49lbs

Temperature rating:

Minimum Maximum
-40°C -40°F +80°C +176°F

TECHNICAL DRAWING

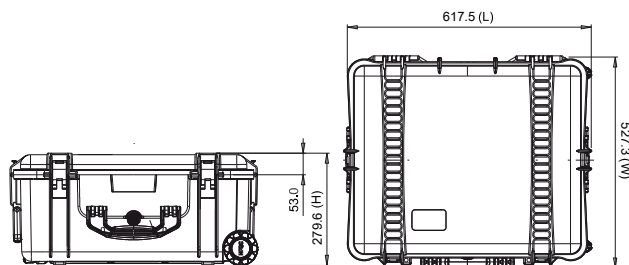





YUNEEC

SPECIAL CASES 2022

HPRC4600W for Yuneec Typhoon H TYH-4600W-01



- 1 Yuneec Typhoon H
- 2 Spare Battery
- 3 Remote Controller
- 4 2 Kits of Spare Props
- 5 Transformer
- 6 Charger
- 7 Miscellaneous Accessories
- 8 Small Accessories / Cables
- 9 Small Tools
- 10 Sunshade



HPRC YUNEEC TYPHOON H

TECHNICAL FEATURES

Dimension:

internal dimension
611x611x375(mm) - 24.05x24.05x14.76(in)
external dimension
670x677x418,5(mm) - 26.38x26.65x16.48(in)

Weight:

empty: 10,70kg - 23.54lbs
with foam: 12,5kg - 27.55lbs

Temperature rating:

Minimum Maximum
-40°C -40°F +80°C +176°F



TECHNICAL DRAWING

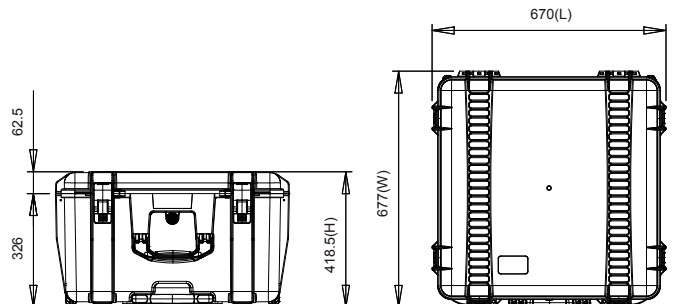



CHASING-INNOVATION

SPECIAL CASES 2022

HPRC2710 for Chasing Innovation Gladius Mini Rev. 2

GLA2710-02



- 1** Chasing Innovation Gladius Mini
- 2** Remote Controller
- 3** Winder & Tether
- 4** Power Adapter
- 5** Cable

HPRC GLADIUS MINI

TECHNICAL FEATURES

Dimension:

Internal dimension
555x459x256(mm) - 21.85x18.07x10.08(in)
External dimension
617x525x280(mm) - 24.29x20.67x11.02(in)



Weight:

empty: 6,71kg - 14.76lbs

Temperature rating:

Minimum Maximum
-40°C -40°F +80°C +176°F

TECHNICAL DRAWING

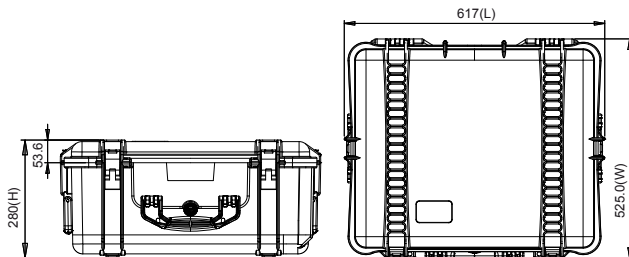

HPRC2710 for Chasing M2 Rov

M2R-2710-01

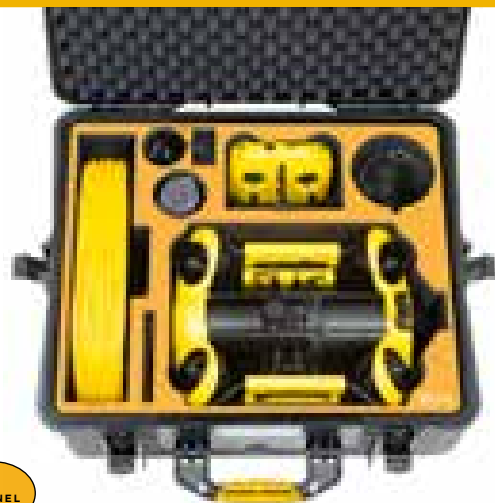

- 1** Drone
- 2** O-rings
- 3** Winder & Tether
- 4** Power Cord & 3 in 1 Charger
- 5** Towel
- 6** Remote Controller
- 7** Battery



HPRC CHASING M2 ROV

TECHNICAL FEATURES

Dimension:

Internal dimension
555x459x256(mm) - 21.85x18.07x10.08(in)
External dimension
617x525x280(mm) - 24.29x20.67x11.02(in)



Weight:

empty: 6,71kg - 14.76lbs

Temperature rating:

Minimum Maximum
-40°C -40°F +80°C +176°F

TECHNICAL DRAWING

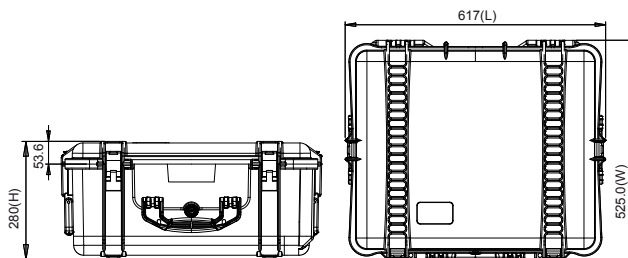





QYSEA



SPECIAL CASES 2022



HPRC2760W for Qysea Fifiish V6S

FIV6S-2760W-01

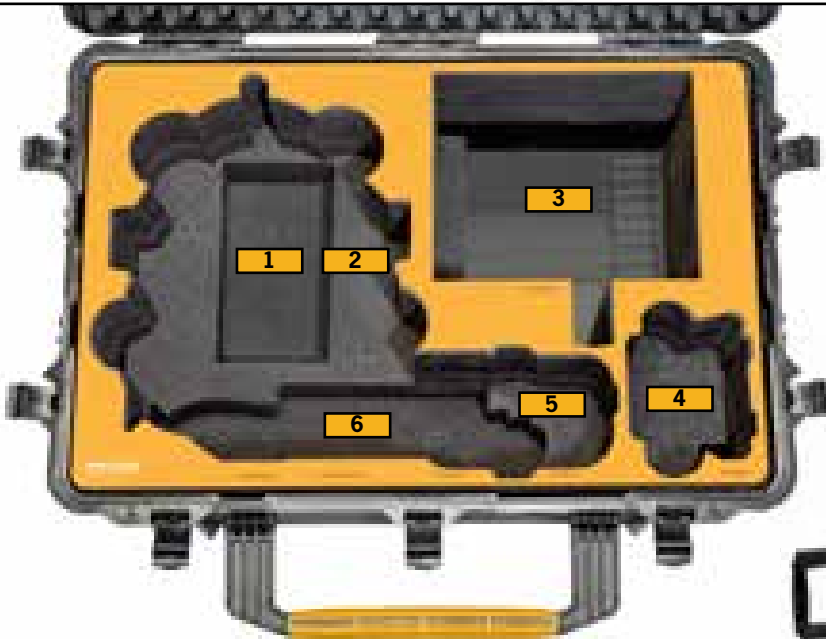
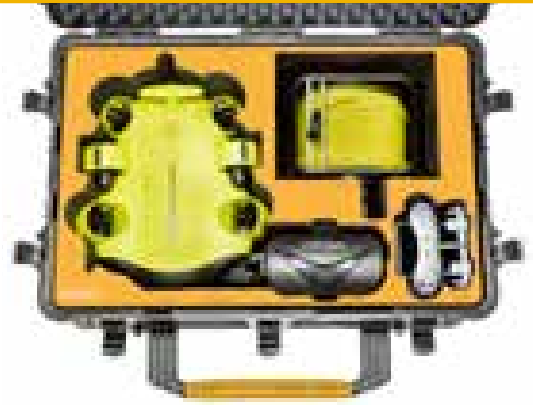

- 1** Charger/Miscellaneous
- 2** FIFISH V6s Underwater Robot
- 3** 100/200M Tether With Reel
- 4** Remote Controller
- 5** VR headtracking box
- 6** 100N Clamping force



TECHNICAL FEATURES

Dimension:

Internal dimension
690x450x301(mm) - 27.16x17.72x11.85(in)
External dimension
750x511x329(mm) - 29.53x20.12x12.95(in)

Weight:

empty: 9,03kg - 19.91lbs
with cubed foam: 10,14kg - 22.35lbs

Temperature rating:

Minimum Maximum
-40°C -40°F +80°C +176°F



TECHNICAL DRAWING

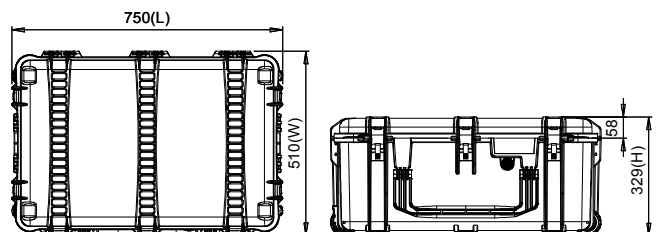



BLACKMAGIC

SPECIAL CASES 2022

HPRC2400 for Blackmagic Pocket Cinema Camera 6K Pro

PKT6P-2400-01

NEW



- 1** Blackmagic Pocket Cinema Camera 6K Pro with or without professional cage
- 2** Lenses: Diameter Max 90mm × Length Max 220mm
- 3** International Adapters
- 4** LP-E6 Battery
- 5** 30W power supply
- 6** HPRC1100MEM

HPRC BLACKMAGIC POCKET CINEMA CAMERA 6K PRO

TECHNICAL FEATURES

Dimension:

Internal dimension
377x263,9x150,8(mm) - 14.84x10.39x5.94(in)
External dimension
402x330,5x169,2(mm) - 15.83x13.01x6.66(in)

Weight:

empty: 2,23kg - 4.91lbs
with cubed foam: 2,55kg - 5.62lbs

Temperature rating:

Minimum Maximum
-40°C -40°F +80°C +176°F



TECHNICAL DRAWING

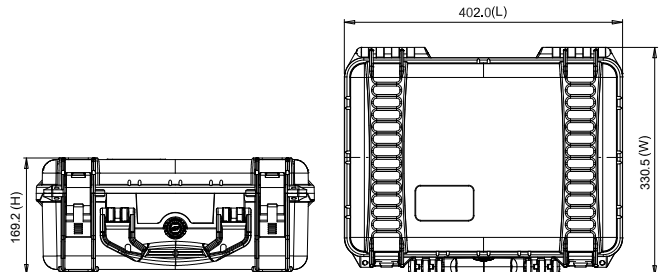

HPRC2400 COMBO for Blackmagic Pocket Cinema Camera 6K or 4K

PKTC-2400-01

NEW



- 1** Cinema Blackmagic Pocket 4K or 6K with or without professional cage and Metabones mounted
- 2** Lenses: Diameter Max 90mm x Length Max 220mm
- 3** International Adapters
- 4** LP-E6 Battery
- 5** 30W power supply
- 6** HPRC1100MEM

HPRC FOR BLACKMAGIC POCKET CINEMA CAMERA 6K 0-4K

TECHNICAL FEATURES

Dimension:

Internal dimension
377x263,9x150,8(mm) - 14.84x10.39x5.94(in)
External dimension
402x330,5x169,2(mm) - 15.83x13.01x6.66(in)

Weight:

empty: 2,23kg - 4.91lbs
with cubed foam: 2,55kg - 5.62lbs

Temperature rating:

Minimum Maximum
-40°C -40°F +80°C +176°F



TECHNICAL DRAWING

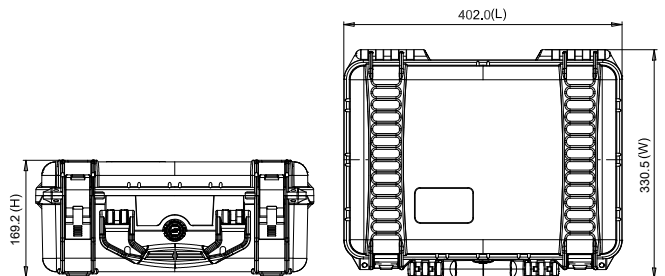

HPRC2300 for ATEM Mini, ATEM Mini Pro and ATEM Mini Pro ISO

AMI-2300-01

NEW



- 1** ATEM Mini/Mini Pro/Mini Pro ISO
- 2** Charger
- 3** Angelbird SSD2GO
- 4** Blackmagic ATEM Streaming Bridge
- 5** HDMI cables/Miscellaneous



HPRC ATEM Mini, ATEM Mini Pro and ATEM Mini Pro ISO

TECHNICAL FEATURES

Dimension:

Internal dimension
305,7x232,4x137,5(mm) - 12.04x9.15x5.41(in)
External dimension
334,6x303x155,2(mm) - 13.17x11.93x6.11(in)



Weight:

empty: 1,75kg - 3.86lbs
with cubed foam: 1,90kg - 4.19lbs

Temperature rating:

Minimum Maximum
-40°C -40°F +80°C +176°F

TECHNICAL DRAWING

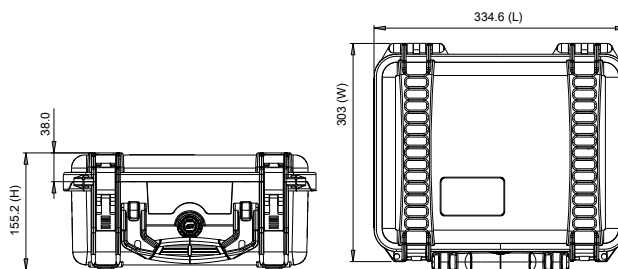

HPRC2500 for ATEM Mini Extreme and Atem Mini Extreme ISO

AME-2500-01

NEW



- 1** ATEM Mini Extreme/Mini Extreme ISO
- 2** Miscellaneous
- 3** Charger
- 4** Blackmagic ATEM Streaming Bridge
- 5** Angelbird SSD2GO
- 6** HDMI cables/Miscellaneous



TECHNICAL FEATURES

Dimension:

internal dimension
449,8x322,9x174,9(mm) - 17.71x12.71x6.89(in)
external dimension
478,1x389,4x194(mm) - 18.82x15.33x7.64(in)

Weight:

empty: 3,08kg - 6.79lbs
with cubed foam: 3,71kg - 8.18lbs

Temperature rating:

Minimum Maximum
-40°C -40°F +80°C +176°F



TECHNICAL DRAWING

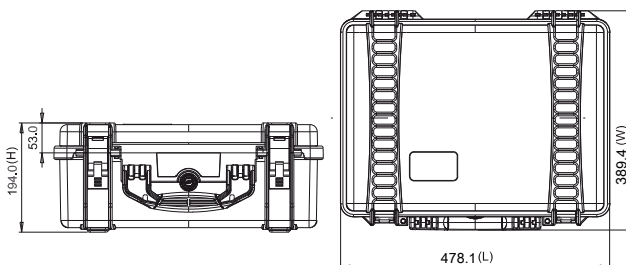

HPRC2710 for Blackmagic Atem 1 M/E

ADV1-2710-01



Blackmagicdesign



1 Blackmagic Design Atem 1 M/E Advanced Panel

TECHNICAL FEATURES

Dimension:
 internal dimension
 555x459x256(mm) - 21.85x18.07x10.08(in)
 external dimension
 617x525x280(mm) - 24.29x20.67x11.02(in)



Weight:
 empty: 6,43 kg - 14.18 lbs
 with foam: 7,45 kg - 16.42 lbs

Temperature rating:
 Minimum Maximum
 -40°C -40°F +80°C +176°F

TECHNICAL DRAWING

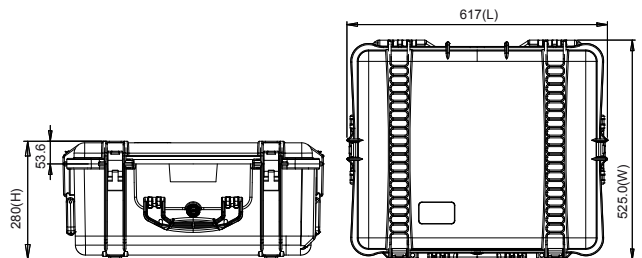

HPRC2730W for Blackmagic Ursa Mini Pro/Broadcast

URS2730W-03



- 1 BlackMagic Ursa Mini Pro / Broadcast with shoulder pad and top handle mounted
- 2 Tripod Plate
- 3 Shoulder Mount kit - Rods clamps
- 4 Batteries
- 5 Lens
- 6 Accessories / Cables
- 7 HPRC1100 Memory card holder for CFast/SDHC cards
- 8 Charger standard and Charger SWIT S-3802S



TECHNICAL FEATURES

Dimension:

internal dimension
503x459x316(mm) - 19.80x18.07x12.44(in)
external dimension
616,9x531x349,6(mm) - 24.29x20.91x13.76(in)

Weight:

empty: 8,41kg - 18.54lbs
with cubed foam: 10,43kg - 22.99lbs

Temperature rating:

Minimum Maximum
-40°C -40°F +80°C +176°F



TECHNICAL DRAWING

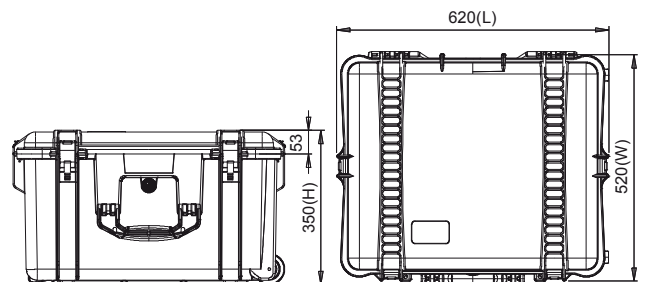





SONY

α
7R

Carl Zeiss

Vario-Tessar FE 4/24-70 ZA OSS

35588032

SONY

SPECIAL CASES 2022

HPRC2460 for Sony Alpha 7 ALP2460-01



HPRC2460 for ALPHA 7 is a special edition, designed to safely carry your SONY Alpha Series.



- 1 Sony A7/A7R/A7S/A7II/A7RII/A7SII/a6300/ Alpha 1 with or without professional cage and lenses mounted (EF/F/PL-Mount/Leica R)
- 2 Lenses: Sony FE 50/1.4, 50/2,8 Macro, 24-70/2.8 G, 85/1,4 G, 16-35/4, 24-70/4, 28-70/3.5-5.6, 28/2.0 - SONY ZA 35/2.8, 35/1.4, 50/1.4, 50/1,8 55/1.8/ 10-18/4 - Zeiss Loxia 21/2.8, 35/2.0, 50/2.0
- 3 Battery chargers, cables
- 4 Accessories (baseplate, rods, top grip handles, lockports, cables, batteries, controllers, GoPro)
- 5 external recorder Atomos/Sound Device etc

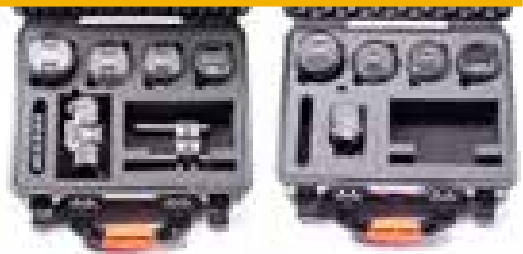

TECHNICAL FEATURES

Dimension:

internal dimension
409x306x175(mm) - 16.1x12.05x6.89(in)
external dimension
435x377,8x193(mm) - 17.13x14.87x7.60(in)

Weight:

empty: 2,57kg - 5.65lbs
with cubed foam: 2,97kg - 6.55lbs

Temperature rating:

Minimum Maximum
-40°C -40°F +80°C +176°F

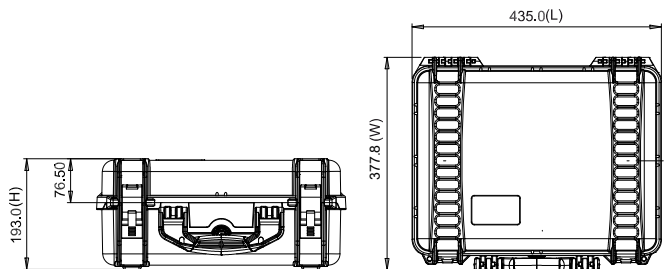

HPRC2400 for Sony FX3

FX3-2400-01

NEW

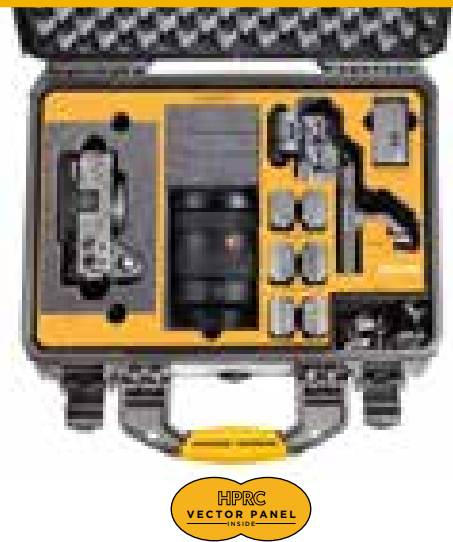

HPRC
VECTOR PANEL



- 1** Sony FX3
- 2** Lenses: Diameter Max 90mm × Length Max 220mm
- 3** XLR Handle Unit
- 4** Battery Charger BC-QZ1
- 5** Battery NP-FZ100
- 6** Cable

HPRC SONY FX3

TECHNICAL FEATURES

Dimension:

Internal dimension
377x263,9x150,8(mm) - 14.84x10.39x5.94(in)
External dimension
402x330,5x169,2(mm) - 15.83x13.01x6.66(in)

Weight:

empty: 2,49kg - 5.48lbs
with cubed foam: 3,20kg - 7.04lbs

Temperature rating:

Minimum Maximum
-40°C -40°F +80°C +176°F



TECHNICAL DRAWING

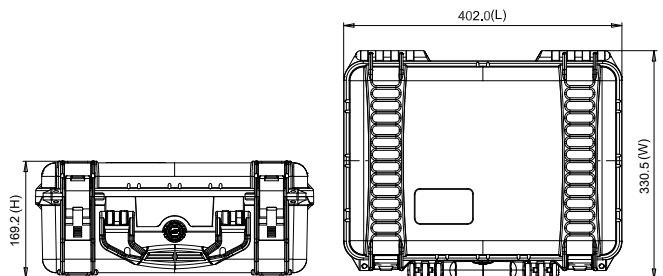

HPRC2550W for Sony ILME-FX6 FX6-2550W-01

NEW

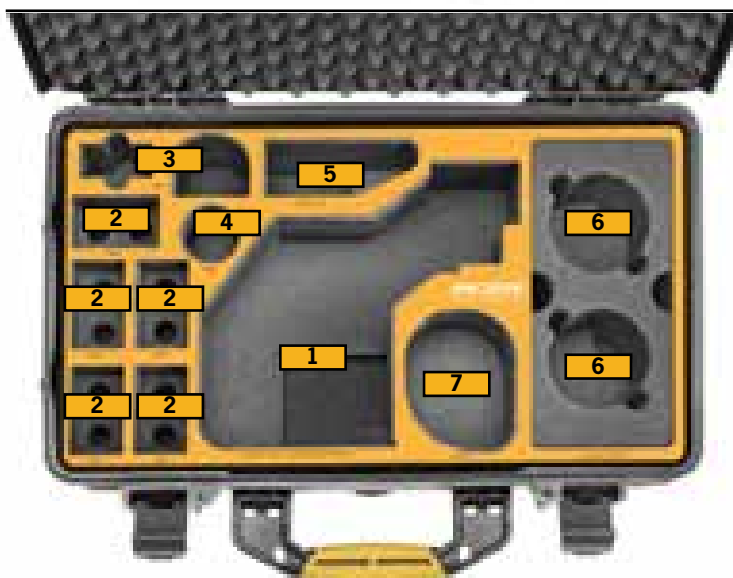

- 1** Sony ILME-FX6 Cinema Line + Smart Handle
- 2** BP-U35 or BP-U100 Battery
- 3** Charger
- 4** Cables
- 5** LCD Monitor 3,5"
- 6** 2x Lenses GM or x Tele GM
- 7** Smart Grip



HPRC SONY ILME-FX6

TECHNICAL FEATURES

Dimension:

internal dimension
513x288x200(mm) - 20.19x11.34x7.87(in)
external dimension
549x346x236(mm) - 21.61x13.62x9.29(in)

Weight:

empty: 4,35kg - 9.57lbs
with foam: 5,04kg - 11.10 lbs

Temperature rating:

Minimum Maximum
-40°C -40°F +80°C +176°F



TECHNICAL DRAWING

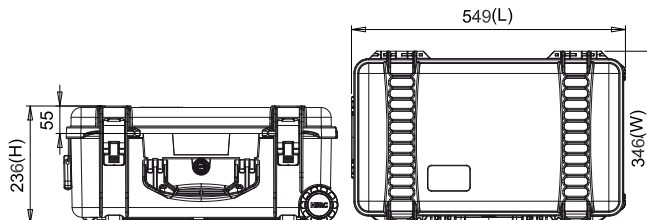

HPRC2700W for Sony PXW-FX9 FX9-2700W-01



SONY
PXW-FX9



- 1 Sony Camcorder
- 2 Viewfinder LCD
- 3 External Microphone
- 4 Battery Sony BP-U Series
- 5 Lens Adapter Metabones
- 6 Sony XQD/SD Card
- 7 Canon CNE Prime Lens
- 8 Cine Lenses up to 105mm Ø
- 9 Photo Lenses up to 105mm Ø
- 10 Hand Grip
- 11 Cable
- 12 Charger
- 13 HPRC1100 MEMBLB

TECHNICAL FEATURES

Dimension:

Internal dimension
554,7x458,7x246(mm) - 21.84x18.06x9.69(in)
External dimension
617,5x527,3x279,6(mm) - 24.31x20.76x11.0(in)

Weight:

empty: 7,75kg - 17.09lbs
with cubed foam: 9,07kg - 19.99lbs

Temperature rating:

Minimum Maximum
-40°C -40°F +80°C +176°F



TECHNICAL DRAWING

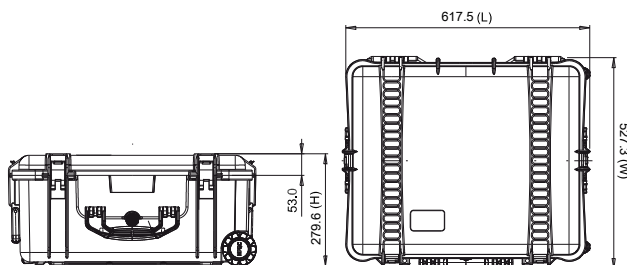

HPRC2730W for Sony Venice

VEN2730W-01



- 1** Sony Venice With Axs-R7 Mounted
- 2** Axs Memory And Sxs Memory Axs-Ar1
- 3** Lanparte Universal Grip Ug-02
- 4** Accessories/Air Evf Mount
- 5** Miscellaneous
- 6** Power Supply V-Lock Pc2l
- 7** Battery V-Lock B100usb/B230usb
- 8** Viewfinder Dvf-EI200
- 9** Hprc1300 Sxs
- 10** Shoulder Mount Accessory Vct-Fsa5
- 11** Tripod Place
- 12** Shoulder Mount Rods

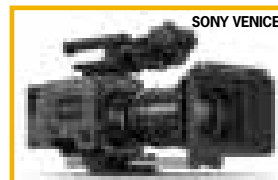

HPRC SONY VENICE

TECHNICAL FEATURES

Dimension:

internal dimension
503x459x316(mm) - 19.80x18.07x12.44(in)
external dimension
616,9x531x349,6(mm) - 24.29x20.91x13.76(in)

Weight:

empty: 8,39kg - 18.49lbs
with cubed foam: 10,19kg - 22.47lbs

Temperature rating:

Minimum Maximum
-40°C -40°F +80°C +176°F



TECHNICAL DRAWING

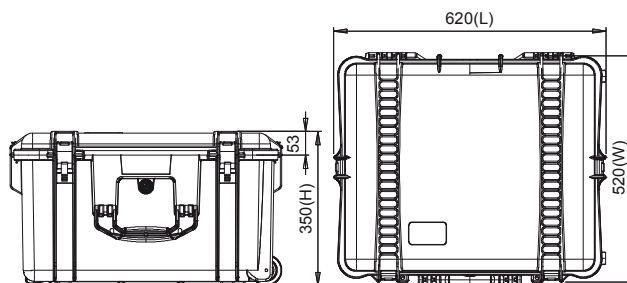

HPRC2600W for Sony PXW-Z280

Z280-2600W-01



- 1** Sony Camcorder PXW-Z280
- 2** Cables/Accessories/Miscellaneous
- 3** Battery Sony BPU – U60
- 4** Compact 4K Wide Conversion
- 5** Microphone



HPRC SONY PXWZ280

TECHNICAL FEATURES

Dimension:

Internal dimension
482,4x358,3x217,6(mm) - 18.99x14.1x8.57(in)
External dimension
546,9x426,8x250,7(mm) - 21.53x16.8x9.87(in)



Weight:

empty: 6,05kg - 13.34lbs
with cubed foam: 6,97kg - 15.37lbs

Temperature rating:

Minimum Maximum
-40°C -40°F +80°C +176°F

TECHNICAL DRAWING

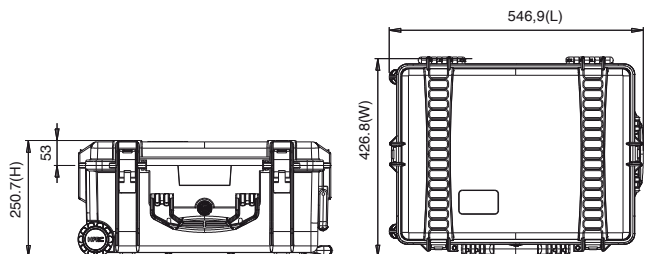

HPRC2700W for Sony PXW-Z190V Z190-2700W-01



SONY
PXWZ190V



- 1** Sony Camcorder PXW-Z190VC
- 2** BC-U1 battery charger
- 3** Battery Sony BPU \Swit S-8U63
- 4** Microphone
- 5** Wireless Audio Set Sony UWP-D11/K51PRO
- 6** Cables/Accessories/Miscellaneous

HPRC SONY PXWZ190V

TECHNICAL FEATURES

Dimension:

Internal dimension
554,7x458,7x246(mm) - 21.84x18.06x9.69(in)
External dimension
617,5x527,3x279,6(mm) - 24.31x20.76x11.0(in)

Weight:

empty: 7,75kg - 17.09lbs
with cubed foam: 9,07kg - 19.99lbs

Temperature rating:

Minimum Maximum
-40°C -40°F +80°C +176°F



TECHNICAL DRAWING

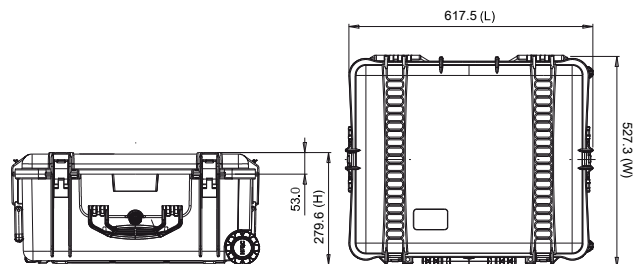

HPRC2730W for Sony PXW-ZFS7

FS7-2730W-01



- 1** Sony PXW-ZFS7
- 2** Viewfinder
- 3** Sony PXW-FS7 FS7 Grip
- 4** HPRC1300 MEMBLB
- 5** VCT-FS7 Lightweight Rod Support System
- 6** 19mm Quick Release
- 7** Miscellaneous
- 8** Rods 9/15/19 mm
- 9** Genlock XDCAFS7
- 10** Charger
- 11** Battery
- 12** Monitor
- 13** Lens 100mm
- 14** Lens 24/70mm
- 15** Box for Metabones PL – E mount T
- 16** Box for Metabones Canon EF Lens to Sony E - mount T



HPRC SONY FS7

TECHNICAL FEATURES

Dimension:

internal dimension
503x459x316(mm) - 19.80x18.07x12.44(in)
external dimension
616,9x531x349,6(mm) - 24.29x20.91x13.76(in)

Weight:

empty: 8,41kg - 18.54lbs
with cubed foam: 10,43kg - 22.99lbs

Temperature rating:

Minimum Maximum
-40°C -40°F +80°C +176°F



W

TECHNICAL DRAWING

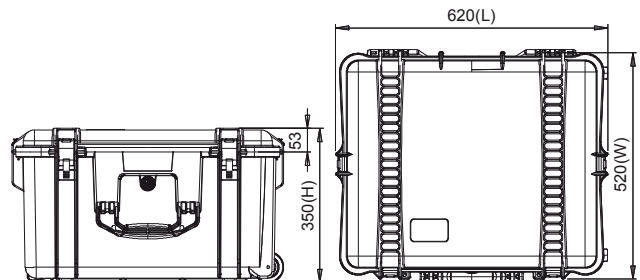





Z CAM

SPECIAL CASES 2022

HPRC2400 for Z CAM E2-F6 Full Frame 6K Cinema Camera ZE2F6-2400-01



- 1** Z CAM E2-F6 Full Frame 6K Cinema Camera with SmallRig Cage mounted
- 2** Alternative Lens Mount
- 3** Accessories
- 4** Charger
- 5** Cable
- 6** NF-P Battery
- 7** CFast 2.0
- 8** WiFi Antenna



HPRC Z CAM E2-F6

TECHNICAL FEATURES

Dimension:

Internal dimension
377x263,9x150,8(mm) - 14.84x10.39x5.94(in)
External dimension
402x330,5x169,2(mm) - 15.83x13.01x6.66(in)

Weight:

empty: 2,23kg - 4.91lbs
with cubed foam: 2,49kg - 5.49lbs

Temperature rating:

Minimum Maximum
-40°C -40°F +80°C +176°F



TECHNICAL DRAWING

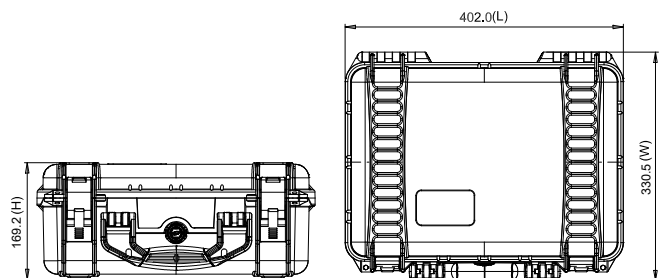



GOPRO

SPECIAL CASES 2022

HPRC1400 for GoPro Hero 7

GPR7-1400-01



- 1 GoPro Hero7 with Camera Frame
- 2 Battery
- 3 SD Card Rack
- 4 Cable
- 5 J-Hook Buckle



HPRC GOPRO HERO7

TECHNICAL FEATURES

Dimension:

internal dimension
180x110x40(mm) - 7.08x4.33x1.57(in)
external dimension
200,3x142,4x48(mm) - 7.89x5.61x1.89(in)

Weight:

empty: 0,26kg - 0.57lbs

Temperature rating:

Minimum Maximum
-40°C -40°F +80°C +176°F



TECHNICAL DRAWING

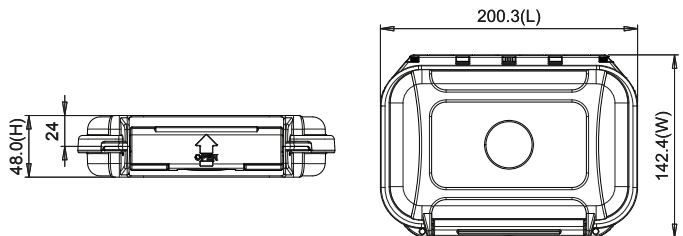



HPRC 2500

FUJIFILM

SPECIAL CASES 2022

HPRC2500 for Fujifilm GFX100

GFX100-2500-01



- 1** Fujifilm GFX100
- 2** Cable storage/Miscellaneous
- 3** Adjustable lens: FUJIFILM GF 110mm f/2 R LM WR Lens, 23mm f/4 R LM WR Lens, 45mm f/2.8 R WR Lens, 32-64mm f/4 R LM WR Lens
- 4** Battery charger
- 5** Battery NP-T125
- 6** Ac Power Adapter

TECHNICAL FEATURES

Dimension:

internal dimension
449,8x322,9x174,9(mm) - 17.71x12.71x6.89(in)
external dimension
478,1x389,4x194(mm) - 18.82x15.33x7.64(in)

Weight:

empty: 3,22kg - 7.10lbs
with cubed foam: 3,75kg - 8.27lbs

Temperature rating:

Minimum Maximum
-40°C -40°F +80°C +176°F

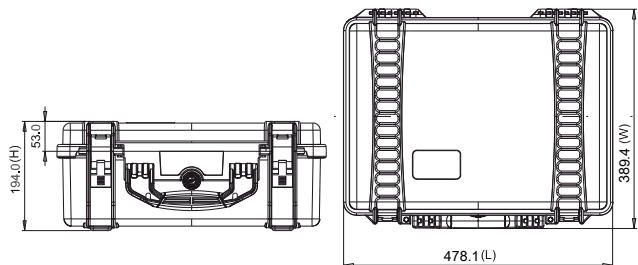



RED

SPECIAL CASES 2022

HPRC2730W for Red Ranger Gemini

RGE-2730W-01

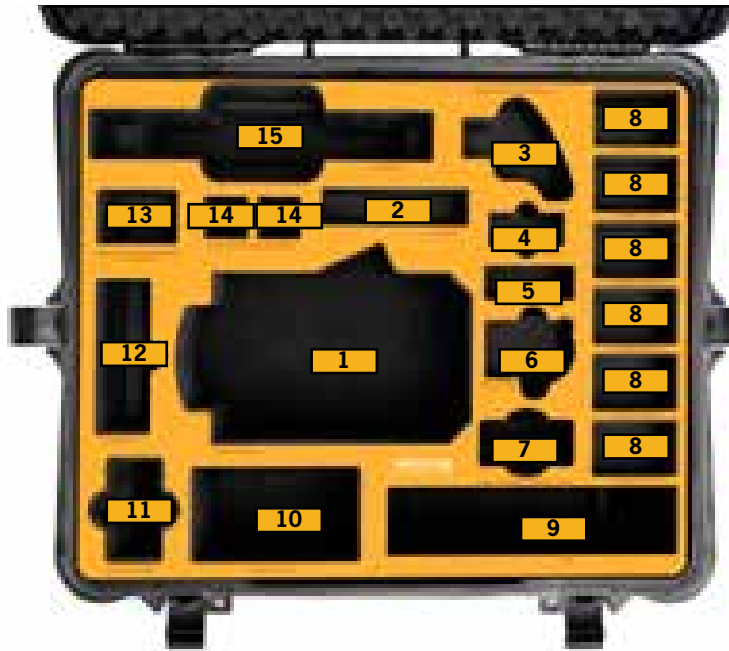

- 1** Camera with Top Handle
- 2** HPRC1300 MEVBLB
- 3** Right Side Wooden Handle 2.0 with R/S Button - Tilta
- 4** Red Mini Mag
- 5** Cable
- 6** Red Bomb EVF DSMC
- 7** Titan Support Arm with Single 1/4" QR Bracket – Monitor Side
- 8** GDU 98Wh Mini V-Lock Battery
- 9** Cable
- 10** BlueShape Travel Charger
- 11** Red Ranger Ac Power Adaptor
- 12** DSMC2 Red Touch 7.0" LCD
- 13** Smallrig for monitor LCD EVF Mount/BMVA/SmallHD, Zacuto Gratical HD1938
- 14** Smallrig Rosette Arm Handle for Shoulder Stabilizer
- 15** Quick Release Platform



HPRC RED RANGER GEMINI

TECHNICAL FEATURES

Dimension:

internal dimension
503x459x316(mm) - 19.80x18.07x12.44(in)
external dimension
616,9x531x349,6(mm) - 24.29x20.91x13.76(in)

Weight:

empty: 8,41kg - 18.54lbs
with cubed foam: 10,43kg - 22.99lbs

Temperature rating:

Minimum Maximum
-40°C -40°F +80°C +176°F



TECHNICAL DRAWING

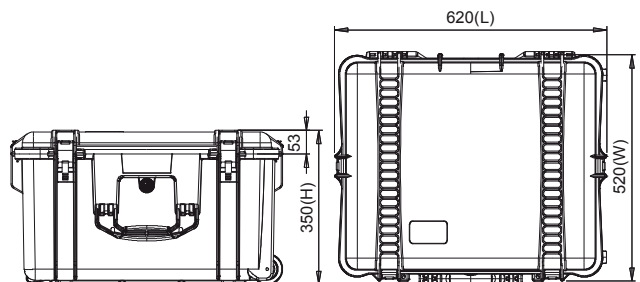

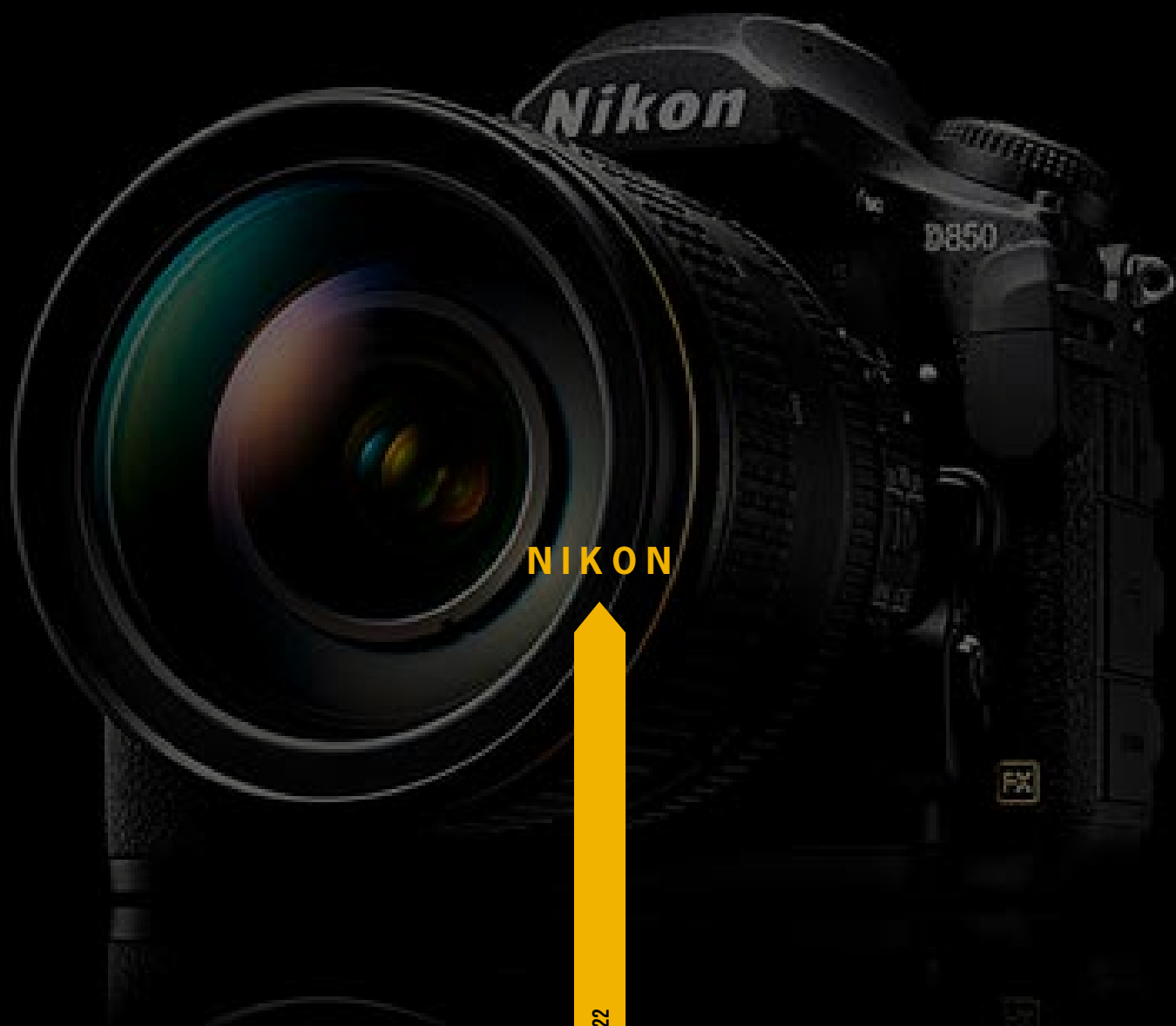

NIKON

SPECIAL CASES 2022

HPRC2460 for Nikon D850

D850-2460-01



for **NIKON D850**



- 1** D850 Camera Body
- 2** Additional EN-EL15a Rechargeable Li-ion Battery
- 3** ME-W1 Wireless Microphone
- 4** ME-1 Stereo Microphone
- 5** Atomos Ninja Flame
- 6** Lenses: AF-S NIKKOR 35mm f/1,8G ED / AF-S NIKKOR 85mm f/1.8G / AF-S NIKKOR 20mm f/1,8G ED
- 7** MH-25A Battery Charger/ UC-E22 USB Cable / Coiled HDMI Cable

HPRC NIKON D850

TECHNICAL FEATURES

Dimension:

internal dimension
409x306x175(mm) - 16.1x12.05x6.89(in)
external dimension
435x377,8x193(mm) - 17.13x14.87x7.60(in)

Weight:

empty: 2,55kg - 5.62lbs
with cubed foam: 3,14kg - 6.92lbs

Temperature rating:

Minimum Maximum
-40°C -40°F +80°C +176°F

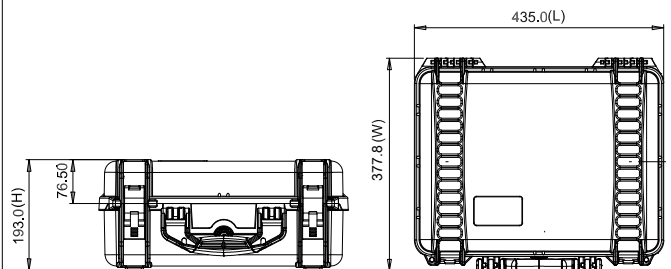



PANASONIC

SPECIAL CASES 2022

HPRC2460 for Panasonic GH5

GH52460-01



HPRC2460 for PANASONIC GH5 is a special edition, designed to safely carry your GH5 Lumix G Series.



- 1 PANASONIC GH5 with or without professional cage and lenses mounted
- 2 Lenses: lumix g 8mm f3,5 (fisheye) hd, lumix dg summilux 12 f1.4, lumix g pancake 14mm f2.5, leica dg summilux 15mm / f1,7 asph, lumix g 20mm f1,7 (asph), leica dg summilux 25mm f1,4 (asph), lumix g 25mm f1.7 asph., lumix g 30mm macro f2,8, leica dg noctricron 42,5 mm f 1,2 (asph) hd, lumix g dg 1,7 / 42,5mm asph/power o.i.s., leica dg macro-elmarit 45mm f2,8 (asph), lumix g vario 7-14mm f4,0 (asph) hd, leica dg vario elmarit 8-18, lumix g vario 12-32mm f3.5-f5.6 (asph) hd, lumix g x vario 12-35mm f2,8 (asph) hd, lumix g x vario 12-35 ii, leica dg vario elmarit 12-60, lumix g vario 12-60, lumix g vario 14-42mm f3,5-5,6 (asph) hd, lumix g vario 14-42mm f3,5-5,6 (asph) hd, lumix g x vario pz 14-42mm f3,5-5,6 (asph), lumix g vario 14-42mm f3,5-5,6 (asph) hd, lumix g x vario pz 14-42mm f3,5-5,6 (asph), lumix g x vario 35-100mm f2,8 hd, lumix g x vario 35-100 ii, lumix g vario 35-100mm f4,0-5,6, lumix g vario 45-200 ii, lumix g 12,5mm f12,5 3d
- 3 Battery chargers, cables
- 4 Accessories (baseplate, rods, top grip handles, lockports, cables, batteries, controllers, GoPro)
- 5 External recorder Atomos/Sound Device etc

HPRC PANASONIC GH5

TECHNICAL FEATURES

Dimension:

internal dimension
409x306x175(mm) - 16.1x12.05x6.89(in)
external dimension
435x377,8x193(mm) - 17.13x14.87x7.60(in)

Weight:

empty: 2,55kg - 5.62lbs
with cubed foam: 3,14kg - 6.92lbs

Temperature rating:

Minimum Maximum
-40°C -40°F +80°C +176°F

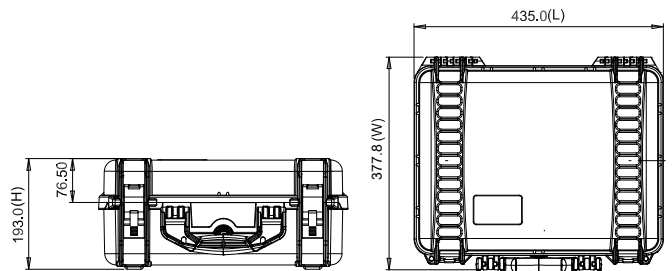



CANON

SPECIAL CASES 2022

HPRC2300 for Canon Eos R5 / R6

CR5-2300-01

NEW



- 1** Canon EOS R5 / R6 Mirrorless Digital Camera (with or without professional cage)
- 2** Lenses: Diameter Max 90mm x Length Max 220mm
- 3** Cable/Miscellaneous
- 4** LC-E6 Charger for LP-E6 Battery Pack
- 5** LP-E6NH Lithium-Ion Battery (7.2V, 2130mAh)



HPRC CANON EOS R5 / R6

TECHNICAL FEATURES

Dimension:

Internal dimension
305,7x232,4x137,5(mm) - 12.04x9.15x5.41(in)
External dimension
334,6x303x155,2(mm) - 13.17x11.93x6.11(in)



Weight:

empty: 1,75kg - 3.86lbs
with cubed foam: 1,90kg - 4.19lbs

Temperature rating:

Minimum Maximum
-40°C -40°F +80°C +176°F

TECHNICAL DRAWING

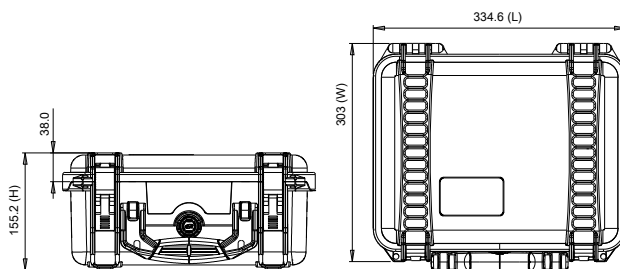

HPRC2700W for CANON EOS C300 MARK III

C300-2700W-01

NEW



- 1 EOS C300 Mark III Body
- 2 Lens CN-E18-80
- 3 Lens 110/90 mm diameter, depth 180mm
- 4 Monitor
- 5 Handle
- 6 Charger
- 7 Various/Cable
- 8 Battery BP-A30/BP-A60
- 9 Charger
- 10 HPRC1100MEM



TECHNICAL FEATURES

Dimension:

Internal dimension
554,7x458,7x246(mm) - 21.84x18.06x9.69(in)
External dimension
617,5x527,3x279,6(mm) - 24.31x20.76x11.0(in)

Weight:

empty: 7,75kg - 17.09lbs

Temperature rating:

Minimum Maximum
-40°C -40°F +80°C +176°F



TECHNICAL DRAWING

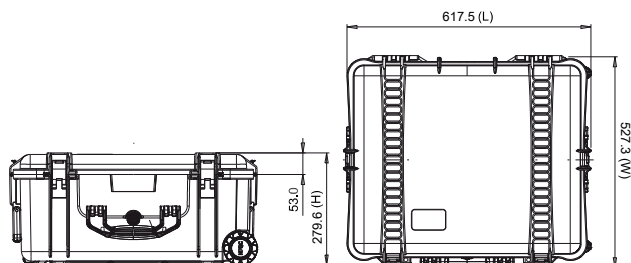



 READY

HPRC2600 for Canon Eos C70

C70-2600-01

NEW



HPRC CANON EOS C70



- 1 Canon Eos C70
- 2 Batteries BP-A60/BP-A30
- 3 Lens Canon RF 24-105 or similar
- 4 Lens Canon RF 15-35 or similar
- 5 Lens Canon RF 70-200 or similar
- 6 Lens Canon RF 24-70 or similar
- 7 Canon Adapter EF-RF 0.71x
- 8 HPRC1300MEMBLB
- 9 CA-CP200L
- 10 Miscellaneous
- 11 Battery Charger CG-A20 OTH
- 12 Handle unit



TECHNICAL FEATURES

Dimension:
 internal dimension
 482,4x358,3x198,1(mm) - 18.99x14.1x7.8(in)
 external dimension
 543,4x426,8x218,1(mm) - 21.39x16.8x8.59(in)



Weight:
 empty: 4,25kg - 9.37lbs
 with cubed foam: 5,05kg - 11.13lbs

Temperature rating:
 Minimum Maximum
 -40°C -40°F +80°C +176°F

TECHNICAL DRAWING

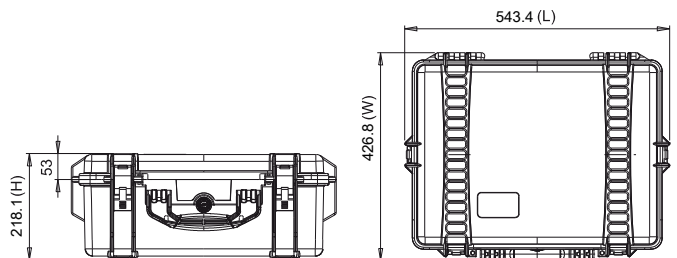

HPRC2600 for Canon Eos C200

C200-2600-01



- 1** Canon Eos C200 With Camera Grip Mounted
- 2** Handle Unit Hdu-2
- 3** Monitor Lcd Lm-V1, Lcd La-V1
- 4** Compact Power Adaptor Ca-A10
- 5** Compact Adaptor Cp200b
- 6** Lenses Ef85mm/16-35/24-70/24-105Mm
- 7** HPRC1100MEM
- 8** Battery Pack A30/A60
- 9** Battery Charger A-20
- 10** Miscellaneous Accessories
- 11** Screw
- 12** Allen Key

HPRC CANON EOS C200

TECHNICAL FEATURES

Dimension:

internal dimension
482,4x358,3x198,1(mm) - 18.99x14.1x7.8(in)
external dimension
543,4x426,8x218,1(mm) - 21.39x16.8x8.59(in)

Weight:

empty: 4,31kg - 9.50lbs
with cubed foam: 4,84kg - 10.663lbs

Temperature rating:

Minimum Maximum
-40°C -40°F +80°C +176°F



TECHNICAL DRAWING

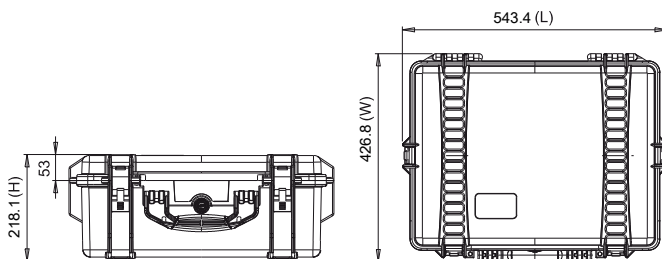

HPRC2600 for Canon Eos C100

C100-2600-01



- 1 Canon Eos C100 With Viewfinder and Camera Grip Mounted
- 2 Handle Unit
- 3 Lenses Ef85mm/16-35/24-70/24-105Mm
- 4 Battery Pack Bp 955
- 5 Battery Pack Bp 975
- 6 Battery Charger Cg-940
- 7 Compact Adaptor Ca-941
- 8 Miscellaneous Accessories
- 9 HPRC1100MEM

HPRC CANON EOS C100

TECHNICAL FEATURES

Dimension:

internal dimension
482,4x358,3x198,1(mm) - 18.99x14.1x7.8(in)
external dimension
543,4x426,8x218,1(mm) - 21.39x16.8x8.59(in)

Weight:

empty: 4,25kg - 9.37lbs
with cubed foam: 5,05kg - 11.13lbs

Temperature rating:

Minimum Maximum
-40°C -40°F +80°C +176°F



TECHNICAL DRAWING

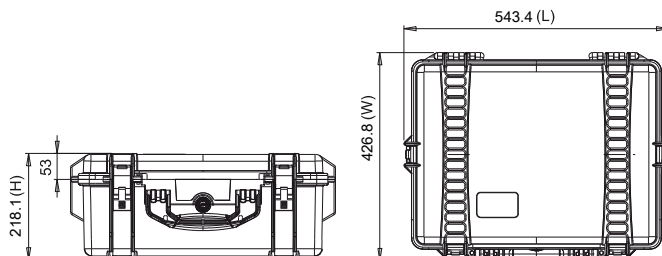





LEICA



LEICA

SPECIAL CASES 2022

SUMILUX-M 1:1.4/35 ASPH.

HPRC2400 for Leica M LEM2400-01



FOR LEICA M



- 1** 1 x Leica M Camera Body with Lens Attached
- 2** Electronic Viewfinder
- 3** 4 x Lens
- 4** Charger
- 5** Spare Battery
- 6** Cables/Miscellaneous

HPRC LEICA M

TECHNICAL FEATURES

Dimension:

Internal dimension
377x263,9x150,8(mm) - 14,84x10,39x5,94(in)

External dimension
402X330,5X169,2(mm) - 15.83x13.01x6.66(in)

Weight:

empty: 2,38kg - 5.25lbs

Temperature rating:

Minimum Maximum
-40°C -40°F +80°C +176°F

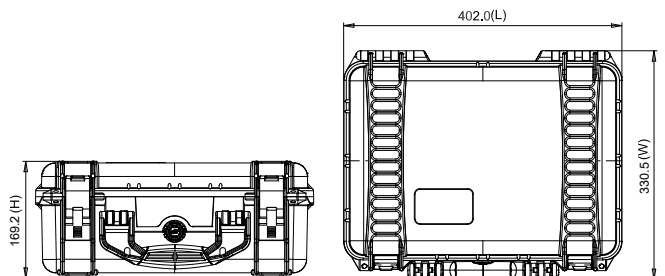

HPRC2460 for Leica M LEM2460-01



FOR LEICA M



- 1** 2 x Leica M Camera Body with Lens Attached
- 2** 2 x Electronic Viewfinder
- 3** 2 x Spare Batteries
- 4** 4 x Lens
- 5** 2 x Charger
- 6** Cables/Miscellaneous

HPRC LEICA M

TECHNICAL FEATURES

Dimension:

internal dimension
409x306x175(mm) - 16.1x12.05x6.89(in)
external dimension
435x377,8x193(mm) - 17.13x14.87x7.60(in)

Weight:

empty: 2,55kg - 5.62lbs
with cubed foam: 3,14kg - 6.92lbs

Temperature rating:

Minimum Maximum
-40°C -40°F +80°C +176°F

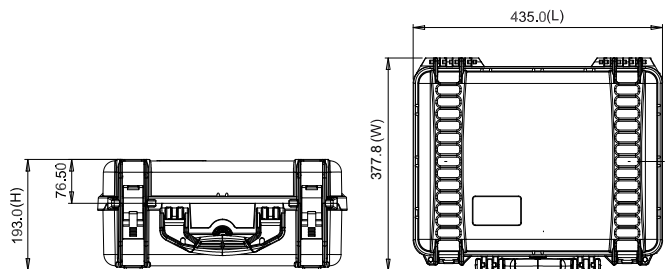



11
10
9
8
7
6
5
4
3
2
1



MP
200
100
0

I



BROMPTON

BROMPTON



SPECIAL CASES 2022

HPRC4800W for Brompton BRO4800W-01

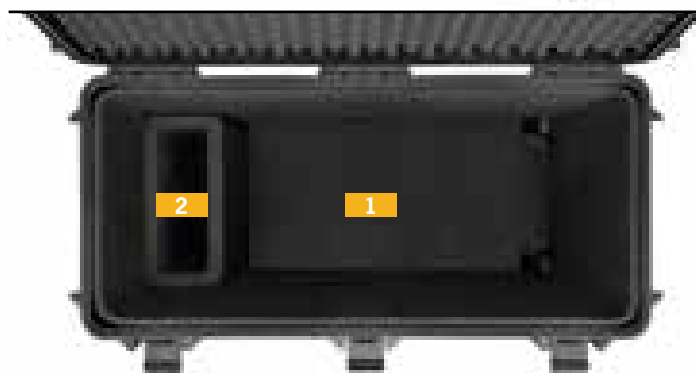

- 1 Brompton Bike
- 2 Accessories



HPRC BROMPTON

TECHNICAL FEATURES

Dimension:

internal dimension
720x320x600(mm) - 28.34x12.60x23.62(in)
external dimension
776x380x649(mm) - 30.55x14.96x25.55(in)

Weight:

empty: 10,00kg - 22.21lbs
with cubed foam: 14,10kg - 31.08lbs

Temperature rating:

Minimum Maximum
-40°C -40°F +80°C +176°F



TECHNICAL DRAWING

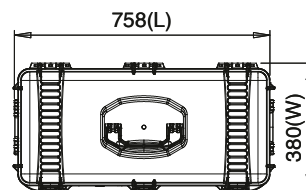
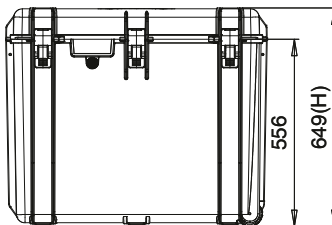



APPLE



SPECIAL CASES 2022



HPRC4800W for Apple Mac Pro MPRO-4800W-01

NEW



HPRC
VECTOR PANEL
INSIDE

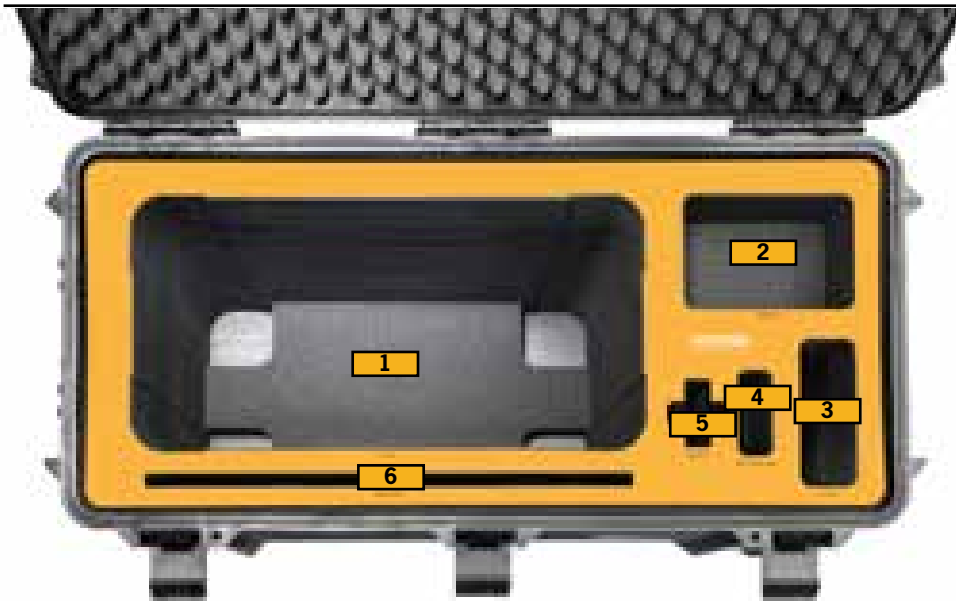

- 1 Mac Pro
- 2 Miscellaneous
- 3 Power cord
- 4 USB-C to Lightning Cable
- 5 Magic Mouse 2
- 6 Magic Keyboard

HPRC APPLE MAC PRO 2020

TECHNICAL FEATURES

Dimension:

internal dimension
720x320x600(mm) - 28.34x12.60x23.62(in)
external dimension
776x380x649(mm) - 30.55x14.96x25.55(in)

Weight:

empty: 10,00kg - 22.21lbs
with cubed foam: 14,10kg - 31.08lbs

Temperature rating:

Minimum Maximum
-40°C -40°F +80°C +176°F



TECHNICAL DRAWING

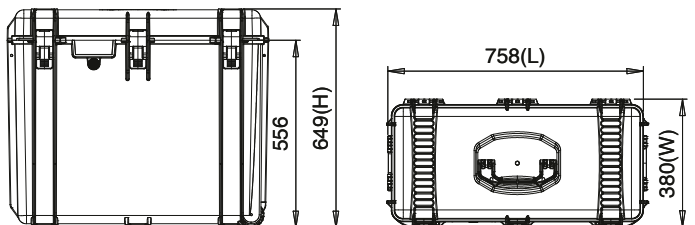



HPRC4800W for Apple IMac 27" - IMacPro

MAC4800W-01



- 1** Apple IMac 27" - IMacPro
- 2** Cable
- 3** Keyboard + Mouse



HPRC APPLE IMAC 27" - IMACPRO

TECHNICAL FEATURES

Dimension:

internal dimension
720x320x600(mm) - 28.34x12.60x23.62(in)
external dimension
776x380x649(mm) - 30.55x14.96x25.55(in)

Weight:

empty: 10,00kg - 22.21lbs
with cubed foam: 14,10kg - 31.08lbs

Temperature rating:

Minimum Maximum
-40°C -40°F +80°C +176°F



TECHNICAL DRAWING

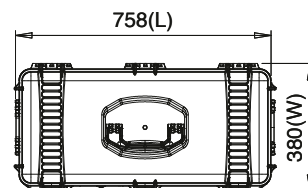
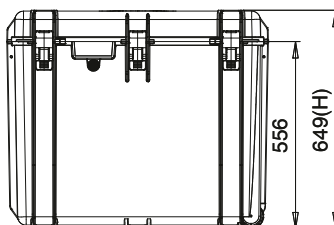

HPRC2350 for MacPro13" + accessories

MPRO-2350-01



- 1** MacBook Pro 13"
- 2** Miscellaneous

HPRC APPLE MACPRO 13"

TECHNICAL FEATURES

Dimension:

internal dimension
340x235x99(mm) - 13.39x9.25x3.90(in)
external dimension
365x293x115,5(mm) - 14.37x11.54x4.55(in)

Weight:

empty: 1.49kg - 3.29lbs
with cubed foam: 1.66kg - 3.65lbs

Temperature rating:

| | |
|-------------|--------------|
| Minimum | Maximum |
| -40°C -40°F | +80°C +176°F |



TECHNICAL DRAWING

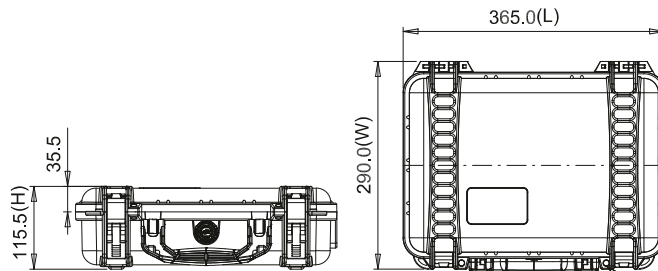

HPRC2400 for MacPro15" + accessories

MPRO-2400-01



- 1** MacBook Pro 15"
- 2** Miscellaneous

TECHNICAL FEATURES

Dimension:

Internal dimension
377x263,9x150,8(mm) - 14.84x10.39x5.94(in)
External dimension
402x330,5x169,2(mm) - 15.83x13.01x6.66(in)

Weight:

empty: 2,38kg - 5.25lbs

Temperature rating:

Minimum Maximum
-40°C -40°F +80°C +176°F



TECHNICAL DRAWING

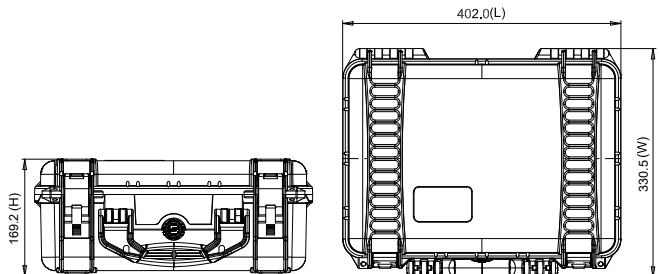

HPRC APPLE MACPRO 15"



EIZO

SPECIAL CASES 2022

HPRC4800W for EIZO 27/24" EIZ27-4800W-01

NEW

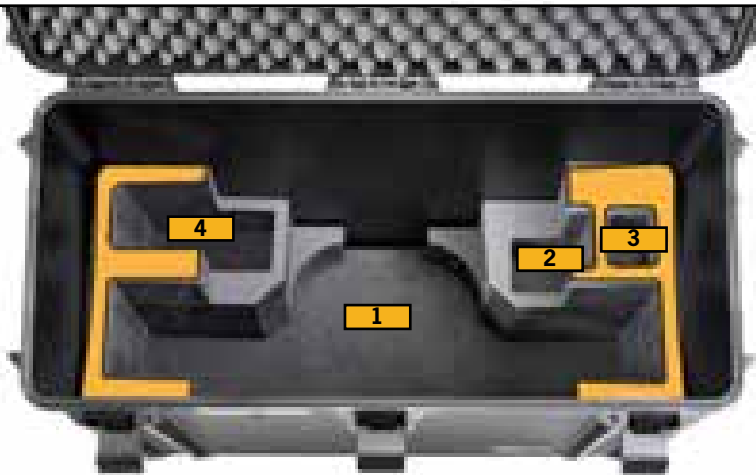

- 1** Eizo Monitor 27" or 24"
- 2** Cables and accessories
- 3** Cables and accessories
- 4** Protective hood and accessories



HPRC EIZO 27/24"

TECHNICAL FEATURES

Dimension:

internal dimension
720x320x600(mm) - 28.34x12.60x23.62(in)
external dimension
776x380x649(mm) - 30.55x14.96x25.55(in)



W

Weight:

empty: 11,12kg - 24.50lbs
with cubed foam: 12,43kg - 27.40lbs

Temperature rating:

Minimum Maximum
-40°C -40°F +80°C +176°F

TECHNICAL DRAWING

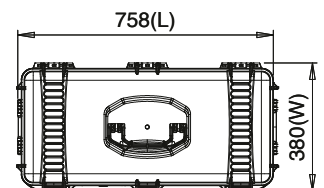
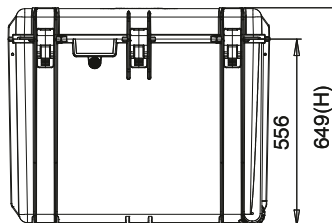



UNIVERSAL MICROPHONES

SPECIAL CASES 2022

HPRC2200 for Universal Microphones

MCF3-2200-01



1 Universal Microphone



TECHNICAL FEATURES

Dimension:

internal dimension
236x182x108(mm) - 9.29x7.17x4.25(in)
external dimension
258x244,3x123,3(mm) - 10.16x9.62x4.85(in)

Weight:

empty: 0,87kg - 1.92lbs
with cubed foam: 1,08kg - 2.38lbs

Temperature rating:

Minimum Maximum
-40°C -40°F +80°C +176°F



TECHNICAL DRAWING

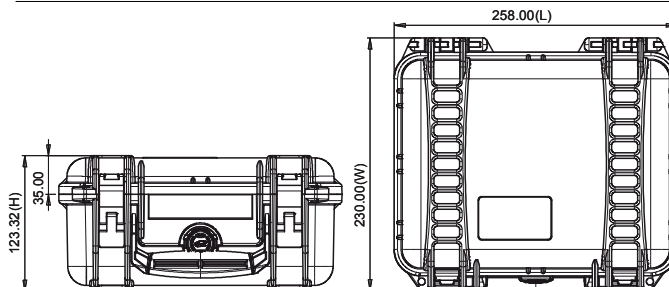

HPRC2250 for Universal Microphones

MCF6-2250-01

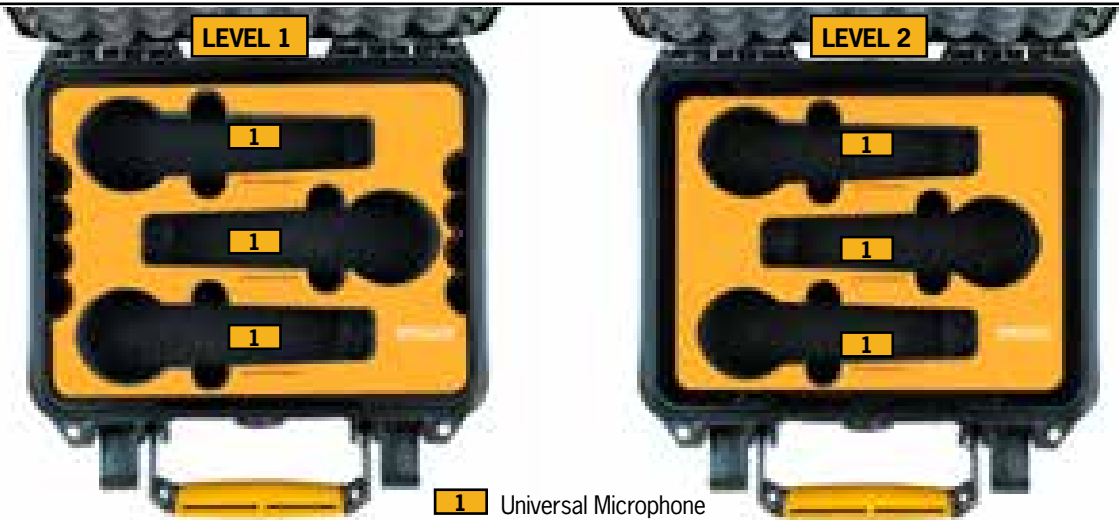

1 Universal Microphone

TECHNICAL FEATURES

Dimension:

internal dimension
236x182x155(mm) - 9.29x7.17x6.10(in)
external dimension
258X230X170(mm) - 10.16x9.06x6.69(in)

Weight:

empty: 1,00kg - 2.20lbs
with cubed foam: 1,35kg - 2.97lbs

Temperature rating:

Minimum Maximum
-40°C -40°F +80°C +176°F



TECHNICAL DRAWING

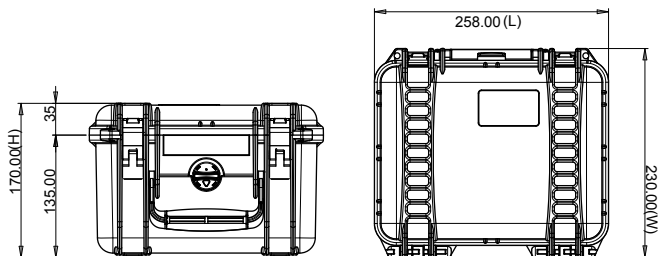



Index

| code | description | page |
|---------------------------|---|------|
| | DJI | 4 |
| PHA4-2710-02 | HPRC2710 FOR DJI PHANTOM 4 | 5 |
| PHA4-2700W-02 | HPRC2700W FOR DJI PHANTOM 4 | 6 |
| PHA4-BAG27-01 | SOFT BAG FOR DJI PHANTOM 4 | 7 |
| PHA4RTK-2700W-01 | HPRC2700W FOR DJI PHANTOM 4RTK / MULTISPECTRAL | 8 |
| PHA4RTKGS-2780W-01 | HPRC2780W FOR DJI PHANTOM4 RTK + GROUND STATION / MULTISPECTRAL | 9 |
| DRTK6500W-01 | HPRC6500W FOR DJI D-RTK2 | 10 |
| M300-2800W-02 | HPRC2800W FOR DJI MATRICE 300 RTK | 12 |
| M600-2800W-01 | HPRC2800W PER DJI MATRICE 600 // MATRICE 600 PRO | 13 |
| BAT2550W-03 | HPRC2550W BATTERY CASE FOR DJI MATRICE 300 | 15 |
| M210-4600W-04 | HPRC4600W FOR DJI MATRICE 200 OR 210 - 2 X CENDENCE CONTROLLERS/ CRYSTALSKY | 16 |
| BAT2550W-02 | HPRC2550W BATTERY CASE FOR DJI MATRICE 200 OR 210 - V. 2.0 | 17 |
| INS2-2780W-02 | HPRC2780W FOR DJI INSPIRE 2 | 18 |
| INS2-4600W-02 | HPRC4600W FOR DJI INSPIRE 2 | 19 |
| BAT2550W-01 | HPRC2550 FOR DJI INSPIRE 2 | 20 |
| SCE-2300-01 | HPRC2300 FOR DJI SMART CONTROLLER ENTERPRISE | 21 |
| CEN2460-02 | HPRC2460 FOR DJI CENDENCE + CRISTAL SKY - REV. 2 | 22 |
| MAV2-2400BLK-02 | HPRC2400 BLACK CASES FOR DJI MAVIC 2 PRO/ZOOM + DJI SMART CONTROLLER | 23 |
| MAV2-3500BLK-02 | HPRC3500 BLACK FOR DJI MAVIC 2 PRO/ZOOM + SMART CONTROLLER | 24 |
| MAVBAG35-03 | HPRC SOFT BACKPACK FOR MAVIC 2 PRO/ZOOM + SMART CONTROLLER | 25 |
| MAV2A-2400-02 | HPRC2400 FOR DJI AIR 2S AND MAVIC AIR 2 REV.02 | 26 |
| MAV2A-2300-01 | HPRC2300 FOR DJI AIR 2S AND MAVIC AIR 2 FLY MORE COMBO | 27 |
| MAV2A-3500-01 | HPRC3500 FOR DJI AIR 2S AND MAVIC AIR 2 FLY MORE COMBO | 28 |
| MAVBAG35-04 | HPRC SOFT BACKPACK FOR DJI AIR 2S AND MAVIC AIR 2 FLY MORE COMBO | 29 |
| MAVM-2300-02 | HPRC2300 FOR DJI MINI 2 COMBO FLY MORE | 30 |
| FPV-2500-01 | HPRC2500 FOR DJI FPV COMBO | 32 |
| FPV-3600-01 | HPRC3600 FOR DJI FPV COMBO | 33 |
| OSMPKT-1400-02 | HPRC 1400 FOR DJI POCKET 2 CREATIVE COMBO KIT | 35 |
| OSMPKT-1400-01 | HPRC1400 FOR DJI OSMO POCKET | 36 |
| OSMACT-1400-01 | HPRC1400 FOR DJI OSMO ACTION | 37 |
| GGG-2460-01 | HPRC 2460 FOR DJI GOGGLES | 38 |
| RSC2-2500-01 | HPRC2500 FOR DJI RSC2 PRO COMBO | 39 |
| RS2-2500-01 | HPRC2500 FOR DJI RS 2 PRO COMBO | 40 |
| RS2-3500-01 | HPRC3500 FOR DJI RS 2 PRO COMBO | 41 |
| RS2-BAG35-01 | SOFT BAG FOR DJI RS 2 PRO COMBO | 42 |
| ROB-2730W-01 | HPRC2730W FOR DJI ROBOMASTER S1 | 45 |
| | AUTEL ROBOTICS | 46 |
| EVO2-2400-02 | HPRC2400 FOR AUTEL EVO II 6K / 8K DRONE - REV. 02 | 47 |
| | ATOMOS | 48 |
| NJAV-2300-01 | HPRC2300 FOR ATOMOS NINJA V | 49 |

| code | description | page |
|----------------|---|------|
| SHG7-2400-01 | HPRC2400 FOR ATOMOS SHOGUN 7" + ACCESSORY KIT | 52 |
| SM19-2730W-01 | HPRC2730W FOR ATOMOS SUMO 19" | 54 |
| | MATTEBOX | 56 |
| T12MB-2600-01 | HPRC2600 FOR TILTA MB-T12 MATTEBOX | 57 |
| | MOZA | 58 |
| MAIR2-2530-01 | HPRC2530 FOR MOZA AIR2 IFOCUS | 59 |
| | ZHIYUN CRANE | 60 |
| CR3-2600W-01 | HPRC2600W FOR ZHIYUN CRANE 3 LAB | 61 |
| CR3-2700W-01 | HPRC2700W FOR ZHIYUN CRANE 3 LAB MASTER PACKAGE | 62 |
| | YUNEEC | 64 |
| TYH-4600W-01 | HPRC4600W FOR TYPHOON H | 65 |
| | CHASING-INNOVATION | 66 |
| GLA2710-02 | HPRC2710 FOR CHASING INNOVATION GLADIUS MINI REV.02 | 67 |
| M2R-2710-01 | HPRC2710 FOR CHASING M2 ROV | 68 |
| | QYSEA | 70 |
| FIV6S-2760W-01 | HPRC2760W FOR QYSEA FIFISH V6S | 71 |
| | BLACKMAGIC | 72 |
| PKT6P-2400-01 | HPRC2400 FOR BLACKMAGIC POCKET CINEMA CAMERA 6K PRO | 73 |
| PKTC-2400-01 | HPRC2400 COMBO FOR BLACKMAGIC POCKET CINEMA CAMERA 6K OR 4K + METABONES | 74 |
| AMI-2300-01 | HPRC2300 FOR ATEM MINI, ATEM MINI PRO AND ATEM MINI PRO ISO | 75 |
| AME-2500-01 | HPRC2500 FOR ATEM MINI EXTREME AND ATEM MINI EXTREME ISO | 76 |
| ADV1-2710-01 | HPRC2710 FOR BLACKMAGIC DESIGN ATEM 1 M/E ADVANCED PANEL | 77 |
| URS2730W-03 | HPRC2730W FOR BLACKMAGIC URSA MINI PRO - URSA BROADCAST | 78 |
| | SONY | 80 |
| ALP2460-01 | HPRC2460 SPECIAL EDITION FOR SONY ALPHA | 81 |
| FX3-2400-01 | HPRC2400 FOR SONY FX3 CINEMA LINE | 82 |
| FX6-2550W-01 | HPRC2550W PER SONY ILME-FX6 CINEMA LINE | 83 |
| FX9-2700W-01 | HPRC2700W FOR SONY PXW-FX9 - CINEMA LINE | 84 |
| VEN2730W-01 | HPRC2730W FOR SONY VENICE - CINEMA LINE | 85 |
| Z280-2600W-01 | HPRC2600W FOR SONY PXW-Z280 | 86 |
| Z190-2700W-01 | HPRC2700W FOR SONY PXWZ190V | 87 |
| FS7-2730W-01 | HPRC2730W FOR SONY FS7 | 88 |
| | Z CAM | 90 |
| ZE2F6-2400-01 | HPRC2400 FOR ZCAM E2-F6 FULL FRAME 6K CINEMA CAMERA | 91 |
| | GO PRO | 92 |
| GPR7-1400-01 | HPRC 1400 FOR GO PRO HERO 7 / 8 | 93 |
| | FUJIFILM | 94 |
| GFX100-2500-01 | HPRC2500 FOR FUJIFILM GFX100 | 95 |
| | RED | 96 |
| RGE-2730W-01 | HPRC2730W FOR RED RANGER GEMINI | 97 |

Index

| code | description | page |
|-----------------------|--|------|
| | NIKON | 98 |
| D850-2460-01 | HPRC2460 FOR NIKON D850 FILMMAKER'S KIT | 99 |
| | PANASONIC | 100 |
| GH52460-01 | HPRC2460 SPECIAL EDITION FOR PANASONIC GH5 AND ACCESSORIES | 101 |
| | CANON | 102 |
| CR5-2300-01 | HPRC2300 FOR CANON EOS R5 / R6 | 103 |
| C300-2700W-01 | HPRC2700W FOR CANON EOS C300 MARK III | 104 |
| C70-2600-01 | HPRC2600 FOR CANON EOS C70 | 106 |
| C200-2600-01 | HPRC2600 FOR CANON EOS C200 | 107 |
| C100-2600-01 | HPRC2600 FOR CANON EOS C100 | 108 |
| | LEICA | 110 |
| LEM2400-01 | HPRC2400 FOR LEICA M | 111 |
| LEM2460-01 | HPRC2460 FOR LEICA M | 112 |
| | BROMPTON | 114 |
| BRO4800W-01 | HPRC4800W FOR BROMPTON FOLDING BIKE | 115 |
| | APPLE | 116 |
| MPRO-4800W-01 | HPRC4800W FOR APPLE MACPRO 2020 | 117 |
| MAC4800W-01 | HPRC4800W FOR APPLE IMAC 27" - IMAC PRO27" | 119 |
| MPRO-2350-01 | HPRC2350 FOR APPLE MACBOOK PRO 13" + ACCESSORIES | 120 |
| MPRO-2400-01 | HPRC2400 FOR APPLE MACBOOK PRO 15" + ACCESSORIES | 121 |
| | EIZO | 122 |
| EIZ27-4800W-01 | HPRC4800W PER MONITOR EIZO 27"E MONITOR EIZO 24" | 123 |
| | UNIVERSAL MICROPHONES | 124 |
| MCF3-2200-01 | HPRC2200 FOR 3 UNIVERSAL MICROPHONES | 125 |
| MCF6-2250-01 | HPRC2250 FOR 6 UNIVERSAL MICROPHONES | 126 |





Plaber s.r.l. - HPRC cases

Via Div Tridentina, 10
I-36061 Bassano del Grappa
Vicenza - Italy

Tel +39 0424 809150
Fax +39 0424 808548

USA office and warehouse:

Plaber America Inc - HPRC cases

110 Chestnut Ridge Rd. #314
Montvale, NJ 07645

Tel +1 201 617 2010
Fax +1 201 617 2001

www.hprc.it | www.hprcusa.com

info@hprc.it

HPRC® Brand owned by:

plaber

SPECIAL CASES 2022

DORSO!